

LED DRIVER SPECIFICATIONS

Customer's Part Number:

MOONS' Part Number:

Model:

ME150H210AQ_CP

P/N:

CUSTOMER'S APPROVAL STAMP

--

Please sign back after your approval. The specifications will come into force when we receive purchase order.

DWG	CHK	STANDARD	APPD.

Rev.	Date	Contents	ECO NO.	DWG	CHK	APPR
A0	2016/12/21	new released		YangZhi	Bilin Tu	Bilin Tu



■ **Features**

- Input voltage: 176-305Vac
- Built-in active PFC function 0.98 Typ.
- High efficiency: up to 93% Typ.
- Built-in Lightning protection
- Three dimming in one operation modes(0-10V Dimming / Clock Dimming(CLK)/PWM Dimming)
- Protection: OVP, SCP, OTP
- Full Power at 65%Iomax~100%Iomax (Constant Power)
- IP67 design for indoor or outdoor installations



Version: A0

■ **Specification**

Model		ME150H210AQ_CP
Input	Efficiency(230Vac)(Typ.)Note.1	92.0%
	Voltage Range (V)Note.2	176~305Vac, OR 250~ 430Vdc (Derating may be need under low inputs, Refer to 'Derating Curve')
	Voltage Rate (V)Note.2	200Vac-240Vac
	Frequency Range (Hz)	47~63
	Power Factor(Typ.)	>0.95 with100% load,at 200Vac-277Vac >0.90 with 80%~100% load,at 200Vac-277Vac
	THD(Typ.)	<15% at 220VAC input 50Hz,80%~100% load <20% at 200Vac-277Vac input 60Hz,60%~100% load
	AC Current(Typ.)	0.85A at 230VAC input
	Inrush Current(Max.)	65A at 230Vac input 25℃ Cold Start (time wide=500uS, measured at 50% Ipeak,Not applicable for the inrush current to Noise Filter for less than 0.2ms)
Output	Leakage Current(Max.)	0.75mA at 277VAC/60Hz input
	Rated Output Voltage (V)	107-71
	Voltage range (V) Note. 4:	107-43
	Rated Current(mA)	1400-2100
	Output Current Range(mA)	140-2100
	Rated Power (W)	150(max)
	Output Current Set Range	6.5%Io_max~100%Io_max
	Constant Power Output Set	65%Io_max~100%Io_max
	Ripple&Noise Current(Typ.)	10% max. ((PK-AV) /AV) with LED default mode and full load)
	Current Tolerance	±5%
	Line Regulation	±1%
	Load Regulation	±3%
Dimming Control	Turn on delay Time	1s(typ.), measured at 230Vac input
	12Vdc Output Voltage (Vdc)	10.8Vmin.~13.2Vmax.
	12Vdc Output Current(Vdc)	0mA~20mA max.
	0~10V/DM+ Voltage	Absolute maximum voltage -10Vmin~20Vmax
	0~10V/DM+ Short Current	280uA~450uA (DIM(+)=0)
Protection	DIMMING FUNCTION	Default 0-10V dimming mode.others Dimming modes set to PWM/Clock Dimming(CLK) by software configuration 140VDC Typ.
	Over Voltage(V)	No damage.The power supply shall be self-recovery when the fault is removed.
	Short Circuit	Protection type: Constant current limiting.
Environment	Over Temperature	Decreases output current,returning to normal after over temperature is removed.
	Operating Temp.	-40~+70℃ (Refer to 'Derating Curve')
	Operating Humidity	20~95%RH, non-condensing
	Tc	90℃ max
	Storage Temp., Humidity	-40~+85℃, 10-95%RH
	Temp. Coefficient	0.03%/℃ (0~50℃)
	Vibration	10-500Hz,5G 12min/cycle, period for 72min each along X、 Y、 Z axes
Safety & EMC	Safety Standard	EN61347-1, EN61347-2-13 ,EN60598-1,EN62384
	Withstand Voltage	I/P-O/P:3.75KVAC I/P-FG:1.875KV O/P-FG:1.5KV
	Isolation Resistance	I/P-O/P, I/P-FG, O/P-FG:100M Ohms/500Vdc/25℃/70%RH
	EMC Emission	EN55015, EN61000-3-2 Class C, EN61000-3-3
Others	EMC Immunity	EN61000-4-2,3,4,5,6,8,11 (Surge L,N-FG 10KV,L-N 10KV) , EN61547
	MTBF	300,000 hours, measured at full load, 25℃ ambient temperature MIL-HDBK-217F(25℃)
	Lifetime	50,000 Hours at Tc 75℃(Refer to"Life Time VS. Tcase (Ref.)")
	Dimension	202 x 67.5 x 40 mm (LxWxH)
	Weight	1.0kg(Typ.)

Note.1: Measured at full load and steady-state temperature in 25℃ ambient(Efficiency will be about 2% lower if measured immediately after startup); Note. 2: Derating may be needed under low input voltages , Please Refer to 'Derating Curve' ; Note. 3: All parameters NOT specially mentioned are measured at 230VAC input , rated load and 25℃ of ambient temperature ; Note. 4: refer to V/I curve

subject to change without notice

Page 3of 7

Operating Curve

Derating Curve

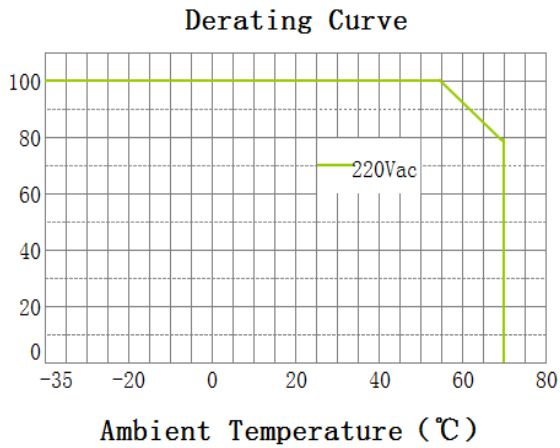

V/I Curve

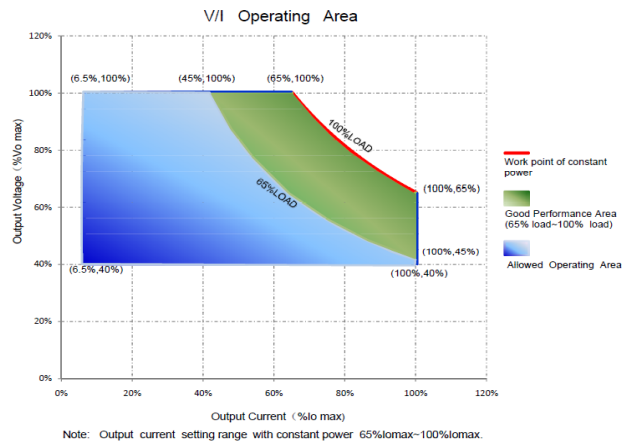

Lifetime vs. Case Temperature

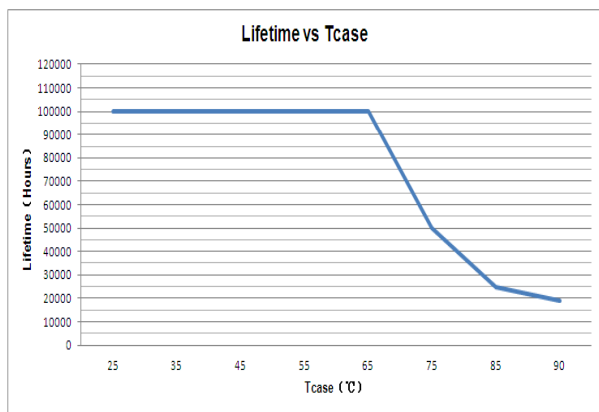

Power Factor Curve

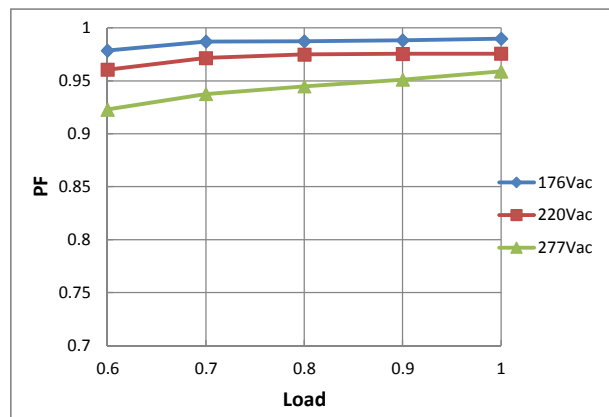

Efficiency VS. Load Curve

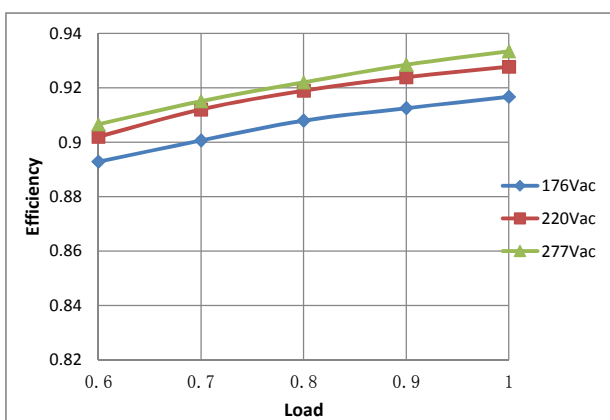

THD Curve

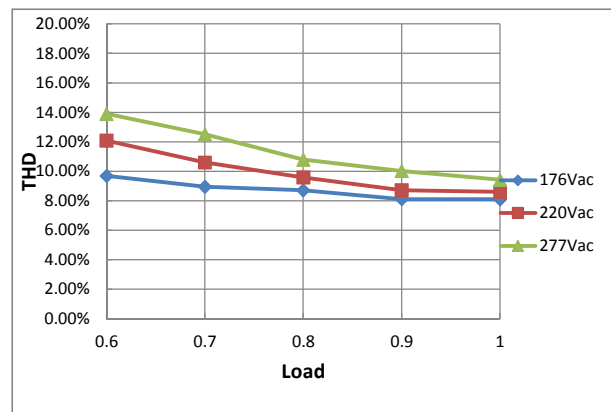

■ Instruction

1.Field Programmable Topology

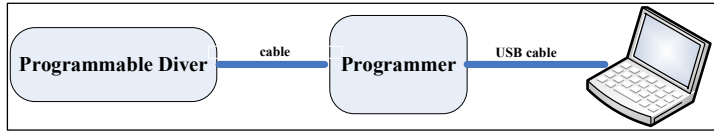

The programmable driver can be programmed by using special PC software and the programmer module.

2.Dimming Interface Description

Pin description

Pin	Name	Value	Description
1	Vaux 12V	10.8V-13.2V	Passive dimmers power supply
2	Dim+/Program	0-10V	Dimming/Programming input
3	Dim-	0V	DC Ground

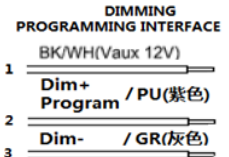

3.Dimming Software Function Instruction

■ Adjustable Output Current(AOC)

Adjustable Output Current(AOC)

Module Current mA

Max Current mA Power W

Users can set the rated current between 7%*Max Current and 100%*Max Current.

■ Adjustable Startup Time(AST)

Adjustable Startup Time(AST)

Start Fadeup Time s

Set driver's "Start Fade up Time". It means how much time the driver costs to achieve the "Module Current" that the user set. The valid value is 0s, 1s, 2s, 5s, 10s, 20s, 40s.

■ Fade Time(FT)

Fade Time(FT)

Fadeup Time s

Set driver's "Fade up Time". This function is available in the Smart Midnight ClockDIM and Fixed ClockDIM mode; It means how much time the driver costs to achieve another dimming level from previous dimming level. The valid value is 0s, 1s, 2s, 5s, 10s, 20s, 40s.

■ 1-10V

Allow users to set the max and min output current and corresponding output voltage to clarify the 1-10V dimming curve. Input a 0~10V signal from 2nd pin of the dimming interface. Default: input ≤1V, output current 10%; input ≥ 8.5V, output current 100%.

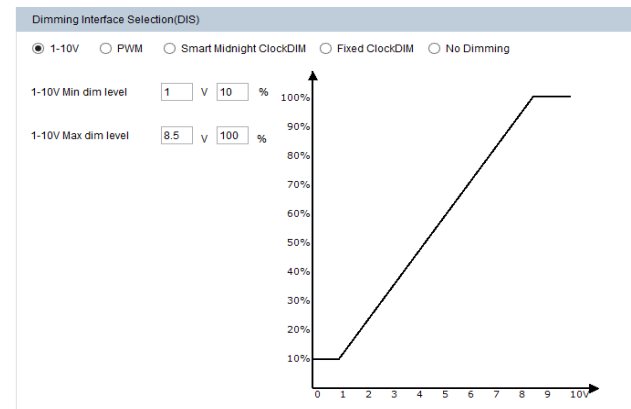

■ PWM

Input a PWM signal from the 2nd pin(Dim+/Program) of the dimming interface to change the output current. User can set "Positive Logic" or "Negative Logic" of the PWM signal. PWM duty circle: 1%~99%(it has both positive and negative logics), frequency: 500Hz~5kHz, 3V~10V is high, -0.3V~0.8V is low.

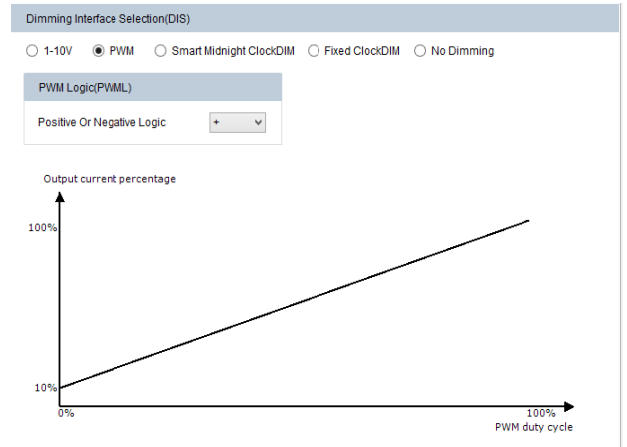

■ Instruction

■ Smart Midnight ClockDIM

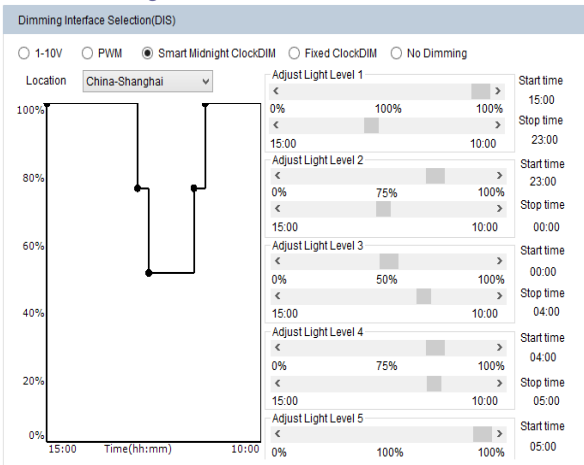

Smart Midnight ClockDIM allows dimming to predefined light levels based on the nightly operating time. With flexibility in setting time and light levels, the user can configure the driver for specific locations and application needs. Using Smart Midnight ClockDIM, it is possible to set up to 5 dim levels and time intervals. The driver does not have a real time clock. Instead it runs a virtual clock, determined by the length of nightly operating hours. After 3 ON-OFF cycles, the driver will calculate the virtual clock time. A valid ON-time is defined as a period during which the driver operates continuously for ≥ 4 hours to ≤ 24 hours. For example, if the requirement in summer is: 23:00-00:00: 75%, 00:00-04:00: 50%, 04:00-05:00: 75% (other time 100% or Off). The driver should be powered on for 7h, so it can calculate the virtual clock time as 22:00. Then we can set the dimming plan: 22:00~23:00: 100%, 23:00-00:00: 75%, 00:00-04:00: 50%, 04:00-05:00: 75%. From summer to winter, the valid ON-time changes day by day. The driver should be powered on for 17h in winter, and it also can calculate the virtual clock time as 17:00. Then the dimming plan is 17:00~23:00: 100%, 23:00-00:00: 75%, 00:00-04:00: 50%, 04:00-05:00: 75%. From the above, if we set the dimming plan as shown in the picture, after repeating the driver ON-time for 3 consecutive days, the dimming plan takes effect from the 4th day onwards. Each day the driver powered on, it has a different start time according to the virtual clock time. So the driver can satisfy different requirements for different seasons.

■ Constant Light Output(CLO)

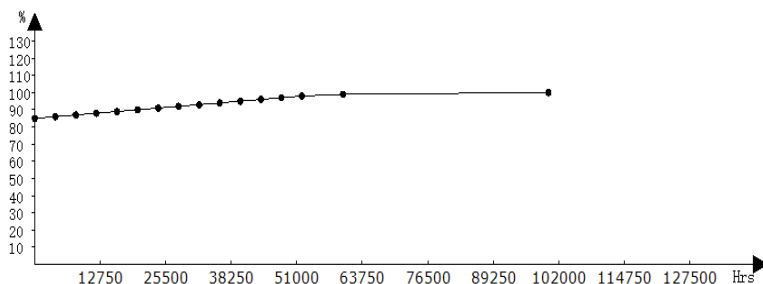
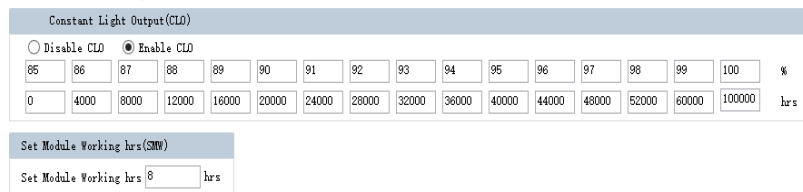

■ Fixed ClockDIM

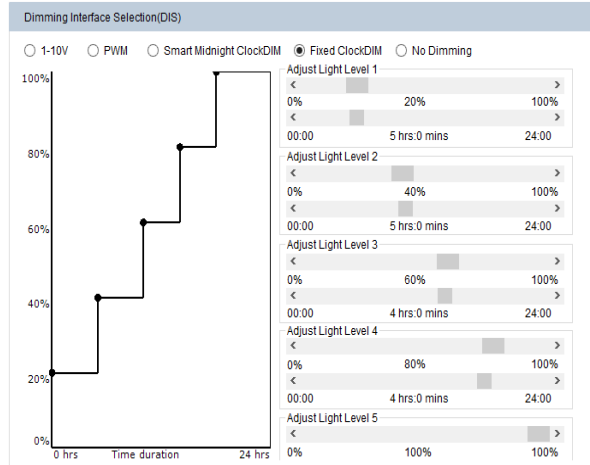

Allow users to separate 24hrs into 5 sections and corresponding output current.

■ No Dimming



The driver will be in constant output mode.

■ Set Module Working hrs(SMW)

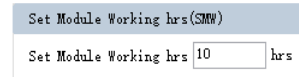

User can check how much time the driver works through this function.

Traditional light sources suffer from depreciation in light output over time. This applies to LED light sources as well. The CLO feature enables LED solutions to deliver constant lumen output through the life of the light engine. Based on the type of LEDs used, heat sinking and driver current, it is possible to estimate the depreciation of light output for specific LEDs and this information can be entered into the driver. The driver counts the number of light source working hours and will increase output current based on this input to enable CLO.

When the CLO feature is enabled, the driver nominal output current will be defined by the CLO percentage as shown by the equation below:
 $\text{Driver target nominal output current} = \text{CLO percentage} * \text{AOC}$
 For example, in the CLO profile shown in Figure, between 52,000-60,000 working hours, the CLO percentage is set at 98%. Assuming the nominal AOC is set to 500mA, the driver output current with CLO enabled will be $0.98 * 500 = 490 \text{ mA}$.

The CLO percentage can be set to a value between 85%-100%, in increments of 1%. The LED module working hours can be set at any value between (0-100,000 hours).

■ Mechanical Specification

Dimensions(Unit:mm)

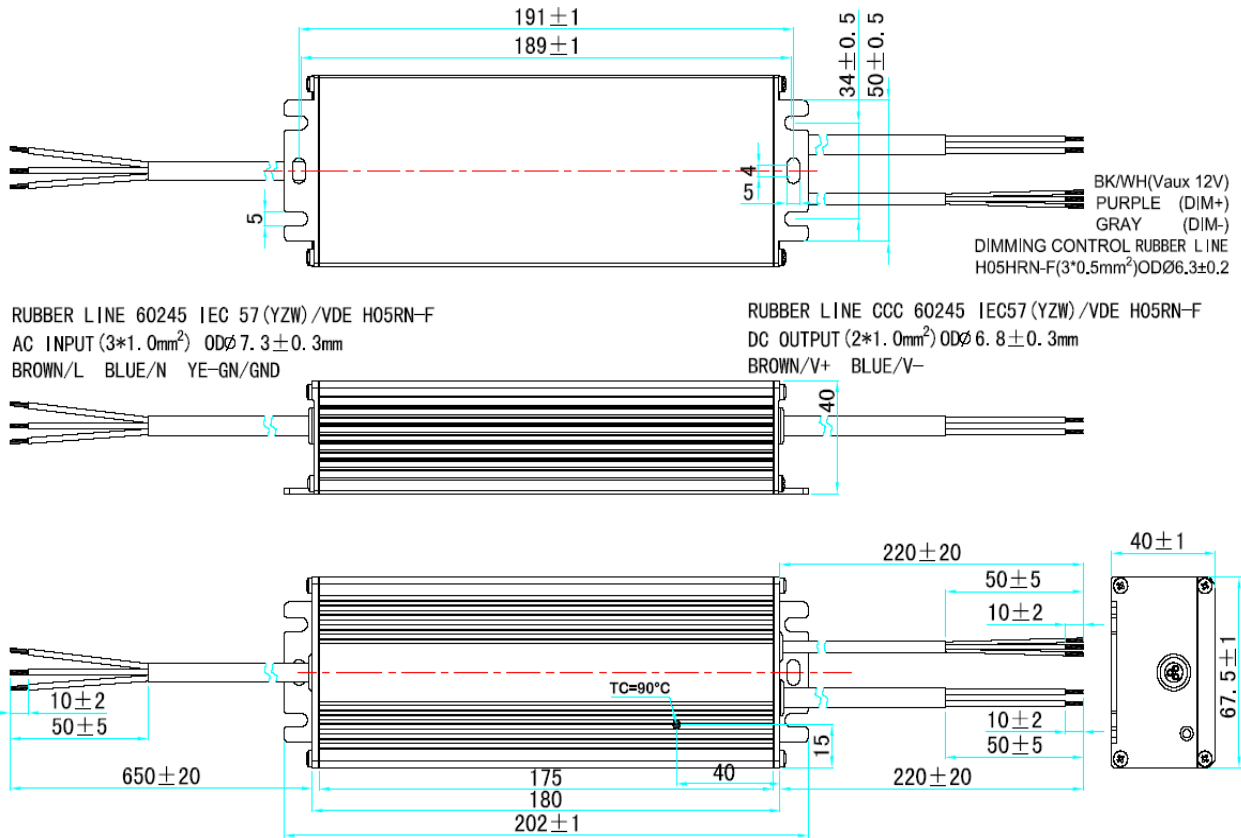

Nameplate:

<ul style="list-style-type: none"> ● AC/L BROWN (棕色) ● AC/N BLUE (蓝色) ● YE-GN (黄绿色) <p>INPUT (输入)</p>	<p>MOONS' LED Driver (LED控制装置) Energy Saving Solutions</p> <p>Http://www.moons.com.cn Http://www.moonsindustries.com</p> <p>SHANGHAI MOONS' AUTOMATION CONTROL CO.,LTD (上海鸣志自动控制设备有限公司) MADE IN CHINA (中国制造)</p>	<p>ME150H210AQ_CP P/N: Input Voltage (输入电压): 200-240Vac 50/60Hz Input Current (输入电流): 0.85A Output Voltage (输出电压): 43-107Vdc Adjustable (自适应) Output Current (输出电流): 2100-1400mA Settable (可设定) U-OUT (最大输出电压): 120V 内置防雷管</p>	<p>Output Current (输出电流): 2100mA Max Output Power (输出功率): 150W tc:90°C ta:55°C PF:0.9</p> <p>SELV IP67 RoHS</p>	<p>DIMMING (调光)</p> <p>Vaux 12V/ BK/WH (棕色) Dim+ Program / PU (紫色) Dim- / GR (灰色)</p> <p>OUTPUT (输出)</p> <p>V- BLUE (蓝色) V+ BROWN (棕色)</p>
---	---	---	--	--

RoHS Compliance:

Our products comply with the European Directive 2002/95/EC, calling for the elimination of lead and other hazardous substances from electronic products.