

Material NO. 4611110029477
物料号

Unit: mm

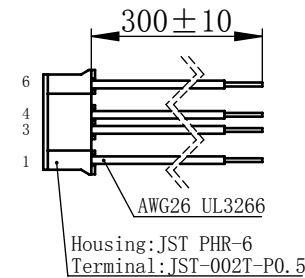
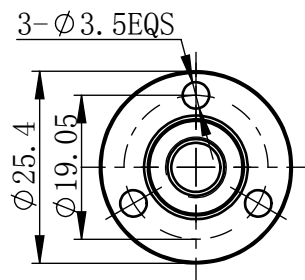
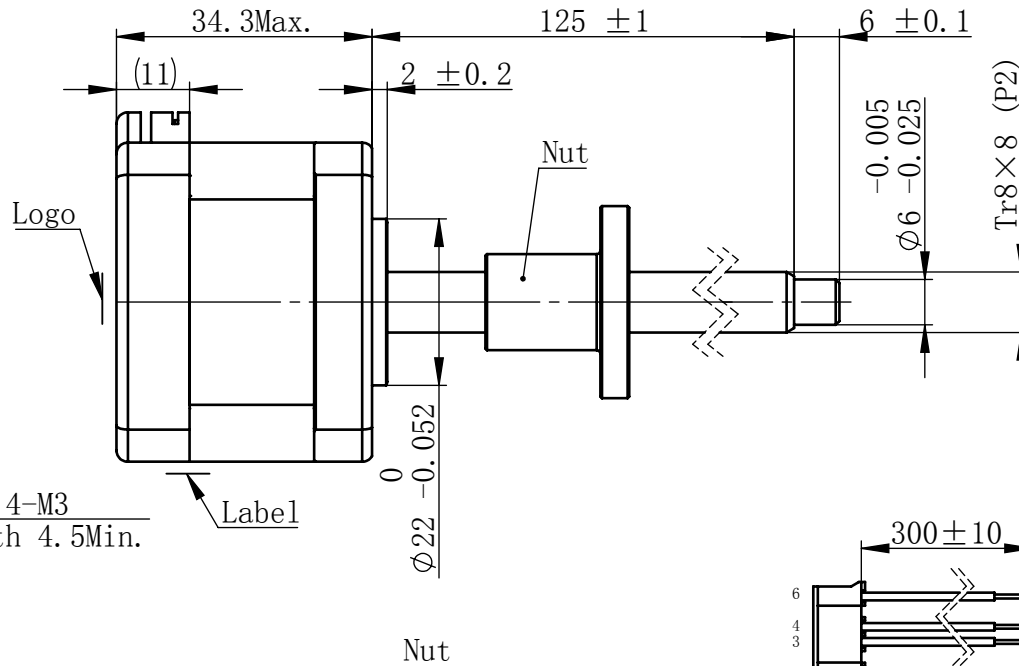
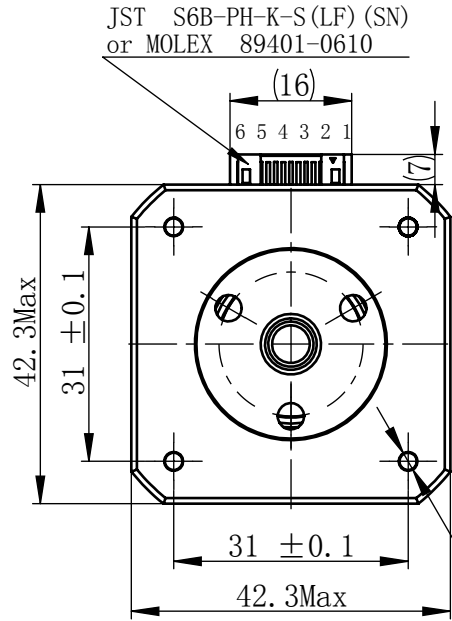

连接器针位 vs. 引线颜色
Pin No. vs. Lead Wire Colour

Pin No.	颜色 Colour
1	黑 BLA
3	绿 GRN
4	红 RED
6	蓝 BLU

接线图
Wiring Diagram

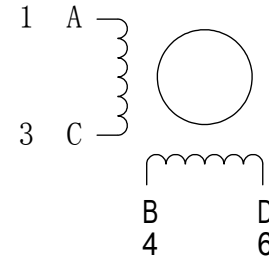

励磁顺序 vs. 旋转方向
Exciting Sequence vs. Direction of Rotation

STEP	A	B	C	D
1	+	+	-	-
2	-	+	+	-
3	-	-	+	+
4	+	-	-	+

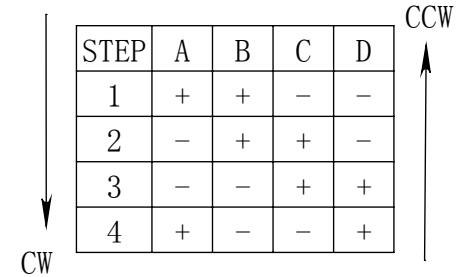

从安装面看为顺时针方向
Clockwise view from mounting side

电机标签
Motor label

LEAD SCREW MOTOR
LE174S-T0808-125-AR3-S-150
XXXXXXXX

批次号

规格
Specifications

1	相数 Number Of Phase	2
2	步长 Linear Travel/Step	0.04 mm (1.8°)
3	额定电压 Rated Voltage	2.625 V DC
4	额定电流 Rated Current	1.5 Amp
5	额定推力 Rated Thrust	42 N(@300rpm, rated current)
6	相电阻 Phase Resistance	1.75 ohm ± 15% (20°C)
7	相电感 Phase Inductance	2.8 mH ± 20% (1kHz 1V rms)
8	转子惯量 Rotor Inertia	38 gcm ²
9	重量 Weight	0.21 Kg
10	绝缘等级 Insulation Class	B(130°C)
11	丝杠直径 Screw Diameter	8 mm
12	丝杠导程 Lead	8 mm

版本变更

版本	变更说明	签名	日期

未标注线性尺寸和公差
Tolerance for linear and dimensions
without individual tolerance indications
GB/T 1804-M eqv ISO 2768-1:M

未标注形状与位置尺寸公差
Geometrical tolerance for features
without individual tolerance indications
GB/T 1184-K eqv ISO 2768-2:K

- I. 请避免螺母脱离丝杠
Keep nut on screw.
- II. 非专业人士请勿拆解电机
Avoid disassembly without qualification.

设计 Design	杨淑娟	2018/7/11
校核 Check		
工艺 Process		
标准化 Standard		
批准 Approve		

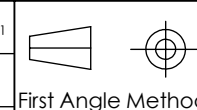

First Angle Method

材料 Material

总图

Page 1 of 1

PBC+MOONS' 上海市闵行区
鸣嘉路168号
上海鸣志派博思自动化技术有限公司 (021)52634688

比例 Scale	零件名 Part Name	直线步进电机
1:1	型号 Model NO.	LE174S-T0808-125-AR3-S-150
	物料号 Material NO.	4611110029477