

Material NO. 4611110029787

Unit: mm

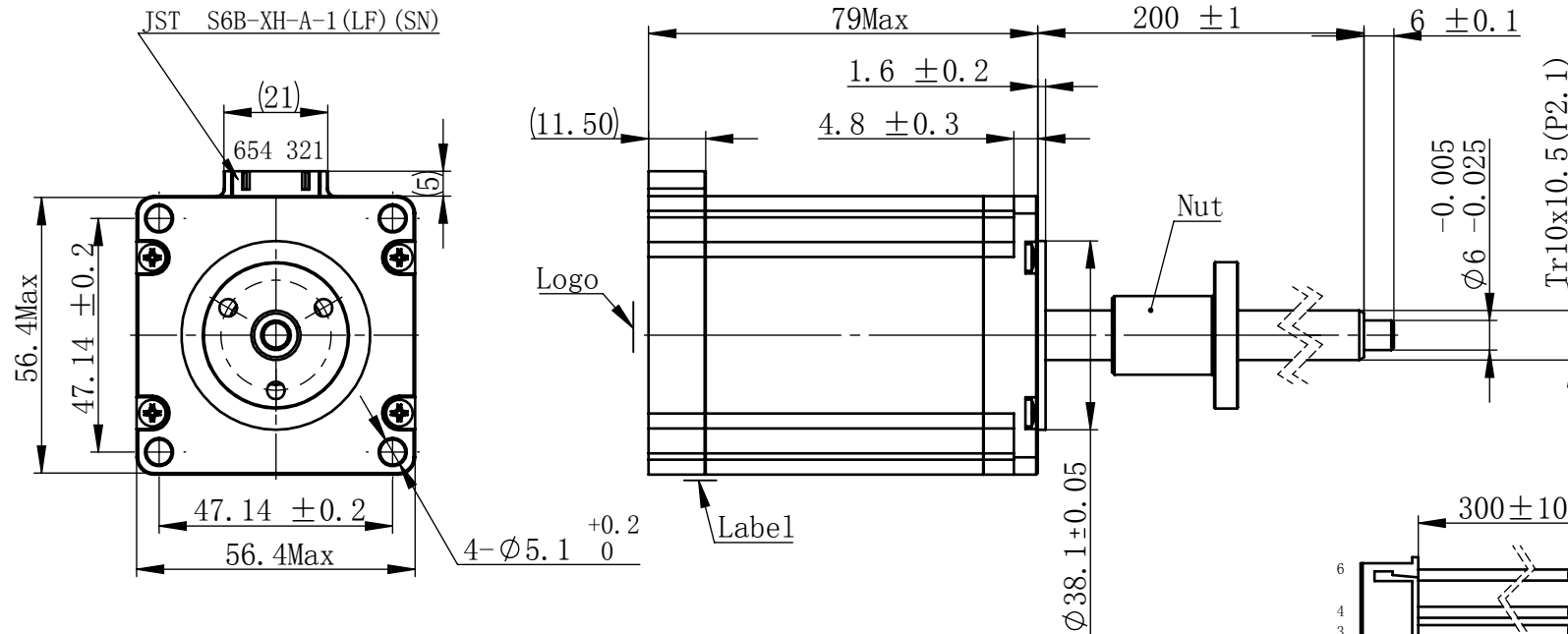

接线图
Wiring Diagram

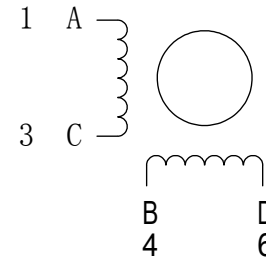

励磁顺序 vs. 旋转方向
Exciting Sequence vs. Direction of Rotation

STEP	A	B	C	D	
1	+	+	-	-	CCW ↑
2	-	+	+	-	
3	-	-	+	+	
4	+	-	-	+	

从安装面看为顺时针方向
Clockwise view from mouting side

规格
Specifications

1	相数 Number Of Phase	2
2	步长 Linear Travel/Step	0.0525 mm (1.8°)
3	额定电压 Rated Voltage	6.5 V DC
4	额定电流 Rated Current	1.5 Amp
5	额定推力 Rated Thrust	95 N(@300rpm, rated current)
6	相电阻 Phase Resistance	4.3 ohm ± 10% (20°C)
7	相电感 Phase Inductance	18.5 mH ± 20% (1kHz 1V rms)
8	转子惯量 Rotor Inertia	365 gm ²
9	重量 Weight	0.84 Kg
10	绝缘等级 Insulation Class	B(130°C)
11	丝杠直径 Screw Diameter	10 mm
12	丝杠导程 Lead	10.5 mm

版本变更

版本	变更说明	签名	日期

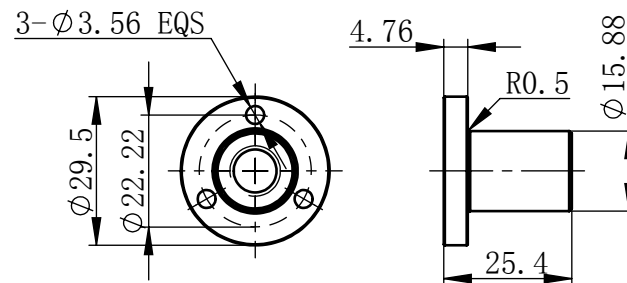

连接器针位 vs. 引线颜色
Pin No. vs. Lead Wire Colour

Pin No.	颜色 Colour
1	黑 BLA
3	绿 GRN
4	红 RED
6	蓝 BLU

电机标签
Motor label

LEAD SCREW MOTOR
LE23AS-T10105-200-AR2-S-150
XXXXXXXX

批次号

未标注线性尺寸和公差
Tolerance for linear and dimensions
without individual tolerance indications
GB/T 1804-M eqv ISO 2768-1:M

未标注形状与位置尺寸公差
Geometrical tolerance for features
without individual tolerance indications
GB/T 1184-K eqv ISO 2768-2:K

- I. 请避免螺母脱离丝杠
Keep nut on screw.
- II. 非专业人士请勿拆解电机
Avoid disassembly without qualification.

设计 Design	杨淑娟	2018/7/16
校核 Check		
工艺 Process		
标准化 Standard		
批准 Approve		

材料 Material	总图
Page 1 of 1	版本 Version A0

上海市闵行区 鸣嘉路168号 上海鸣志派博思自动化技术有限公司 (021)52634688	
比例 Scale	零件名 Part Name 直线步进电机
2:3	型号 Model NO. LE23AS-T10105-200-AR2-S-150
物料号 Material NO.	4611110029787