

## LED DRIVER SPECIFICATIONS

Customer's Part Number:

\_\_\_\_\_

MOONS' Part Number:

\_\_\_\_\_

Model:

MT100A105AQ\_CP/C

\_\_\_\_\_

P/N:

\_\_\_\_\_

### CUSTOMER'S APPROVAL STAMP

Please sign back after your approval. The specifications will come into force when we receive purchase order.

DWG	CHK	STANDARD	APPD.

Rev.	Date	Contents	ECO NO.	DWG	CHK	APPR
A0	2016.04.15	New release		Mingji Lee	Qiang Liu	Bilin Tu
A1	2016.08.03	Add Nameplate	EC016-2176DE	Mingji Lee	Qiang Liu	Bilin Tu
A2	2017.05.08	Change the I/P-FG for 1.96KV	ECN17-0815DE	Mingji Lee	Qiang Liu	Bilin Tu

■ **Features**

- Input voltage: 249-528VAC
- Built-in active PFC function: 0.98Typ.
- Built-in Lightning protection.
- High efficiency: 90% Typ.
- Waterproof (IP67)
- Constant Current / 0-10V Dimming
- Clock Dimming(CLK)/PWM Dimming
- Protection: OVP, SCP, OTP
- Full Power at 65%Iomax~100%Iomax (Constant Power)
- UL Type TL, Type HL



■ **Specification**

MT100A105AQ_CP/C		PN:
Input	Efficiency(277Vac) <sup>Note.1</sup>	88% (Typical) , >86% at full load
	Efficiency(480Vac) <sup>Note.1</sup>	90% (Typical) , >88% at full load
	Voltage Range (V) <sup>Note.2</sup>	249 ~ 528Vac
	Voltage Rated (V) <sup>Note.2</sup>	277-480Vac
	Frequency Range (Hz)	47~63
	Power Factor	0.96 (Typical) , 0.94 (minimum) at 480Vac >0.9 with 60%~100% load, at 277~480Vac
	THD	<15% with 80% ~ 100% load, at 277~480Vac <20% with 60%~100% load, at 277~480Vac
	AC Current(Max)	0.5A MAX at277VAC
	Inrush Current(Max.)	65A at 480Vac input 25°C Cold Start ( time wide=500uS, measured at 50% Ipeak,Not applicable for the inrush current to Noise Filter for less than 0.2ms)
	Leakage Current(Max.)	0.75mA at 480Vac/50Hz
Output	Rated Output Voltage (V)	143-95
	Output Voltage range (V)	143-57
	Rated Current(mA)	700-1050
	Output Current Range(mA)	70-1050
	Rated Power (W)	100(max)
	Output Current Set Range	6.5%Io_max~100%Io_max
	Constant Power Output Set Rang	65%Io_max~100%Io_max
	Ripple Current	<10%((PK-AV) /AV) full load)
	Current Tolerance	5%
	Line Regulation	3%
	Load Regulation	5%
Turn on delay Time	2s(typ.), measured at 277Vac input	
Dimming Control	12Vdc Output Voltage (Vdc)	10.8Vmin.~12Vtyp.~13.2Vmax.
	12Vdc Output Current(Vdc)	0mA~20mA max.
	0~10V/DIM+ Voltage	Absolute maximum voltage -10Vmin~20Vmax
	0~10V/DIM+ Short Current	280uA~450uA (DIM(+)=0)
DIMMING FUNCTION	0~10V/10%Io~100%Io ref. Dimming module diagram and dimming cruve	
Protection	Over Voltage(V)	<200 Protection type: Voltage limiting.output will not exceed the upper limit voltage , recovers automatically after fault condition is removed.
	Over Current	-
	Short Circuit	Protection type: Hiccup mode. recovers automatically after short is removed.
	Over temperature	Protection type: Resumable mode.when the inside temperature of PSU rise to 100°C(Typ.), the PSU will shutdown.The power supply should resume its normal operation when the inside temperature of PSU drop to normal temperature.
Environment	Operating Temp.	-40~+70°C( Refer to 'Derating Curve' )
	Tc	90°C max
	Operating Humidity	20~95% RH non-condensing
	Storage Temp., Humidity	-40~+85°C , 10~95%RH
	Temp. Coefficient	0.03%/°C ( 0~50°C )
Vibration	10-500Hz,5G 12min/cycle , period for 72min each along X、Y、Z axes	
Safety & EMC	Safety Standard	UL8750,UL1012, CSA 250.13
	Withstand Voltage	I/P-O/P:3.75KVAC I/P-FG:1.96KV O/P-FG:1.5KV
	Isolation Resistance	I/P-O/P:100M Ohms (500VDC/25°C/70%RH)
	EMC Emission	Conducted Emission: FCC PART15 Class A, Radiated Emission: FCC PART15 Class A
	EMC Immunity	EN61000-4-2,3,4,5,6,8,11, EN61000-4-5: Line to Neutral: ±6kV ; Line to GND: ±6kV ; Neutral to GND: ±6kV. IEEF / ANSI C62.41.2 Transient Surge Requirements, combi wave 2 ohm source impedance.
Others	MTBF	300,000 hours, measured at full load, 25°C ambient temperature MIL-HDBK-217F(25°C)
	Lifetime	>=100 Khrs lifetime (continuous) at Tcase = 65 °C >=50 Khrs lifetime (continuous) at Tcase = 75 °C
	Dimension	221 x67.5 x37 mm (LxWxH)
	Weight(Typ.)	920g

Note.1: Measured at full load and steady-state temperature in 25°C ambient(Efficiency will be about 2% lower if measured immediately after startup); Note. 2: Derating may be needed under low input voltages , Please Refer to 'Derating Curve'; Note. 3: All parameters NOT specially mentioned are measured at 480VAC input , rated load and 25°C of ambient temperature ;

subject to change without notice

Page 3 of 7

**SHANGHAI MOONS' AUTOMATION CONTROL CO., LTD.**

Add: No.168, Mingjia Road, Shanghai 201107, P.R.China  
Tel: +86 (0)21 52634688 Website: www.moons.com.cn

**Derating Curve**

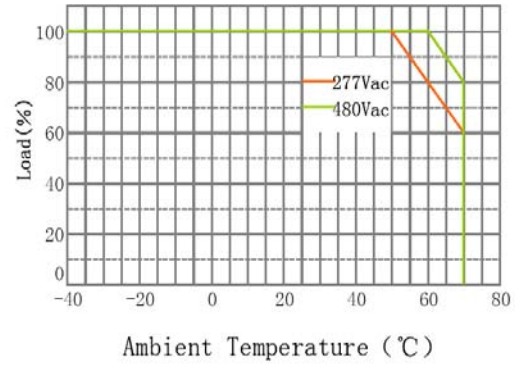
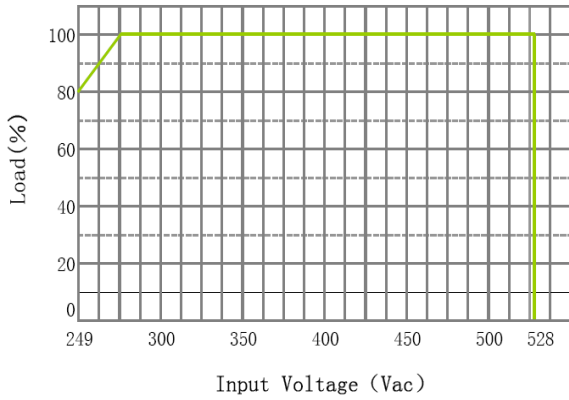

**V/I Curve**

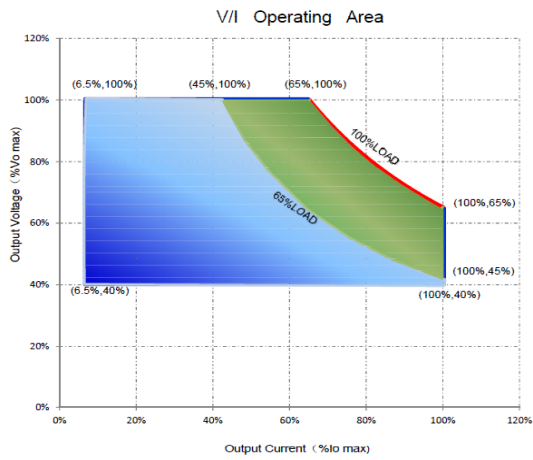

**Life Time VS. Tcase (Ref.)**

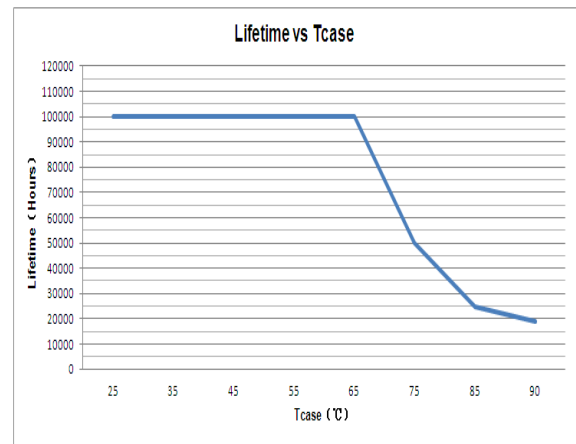

**Life Time VS. Tambient(Ref.)**

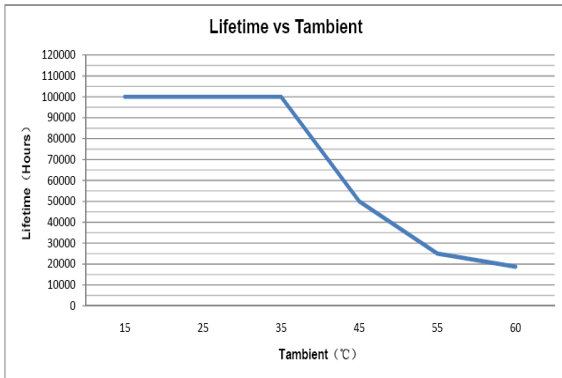

■ **Instruction**

**1.Field Programmable Topology**

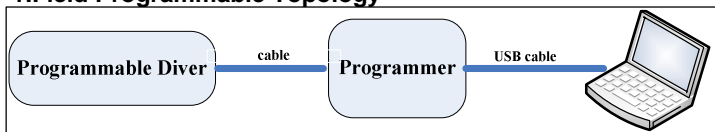

The programmable driver can be programmed by using special PC software and the programmer module.

**2.Dimming Interface Description**

Pin description

Pin	Name	Value	Description
1	Vaux 12V	10.8V-13.2V	Passive dimmers power supply
2	Dim+/Program	0-10V	Dimming/Programming input
3	Dim-	0V	DC Ground

**3.Dimming Software Function Instruction**

■ **Adjustable Output Current(AOC)**

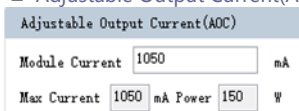

Users can set the rated current between 7%\*Max Current and 100%\*Max Current

■ **PWM**

Input a PWM signal from the 2nd pin(Dim+/Program) of the dimming interface to change the output current. User can set "Positive Logic" or "Negative Logic" of the PWM signal. PWM duty circle: 1%~99%(it has both positive and negative logics ), frequency: 500Hz~5kHz, 3V~10V is high, 0.3V~0.8V is low.

■ **Adjustable Startup Time(AST)**

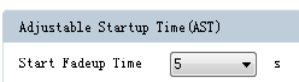

Set driver's "Start Fade up Time". It means how much time the driver costs to achieve the "Module Current" that the user set. The valid value is 0s, 1s, 2s, 5s, 10s, 20s, 40s.

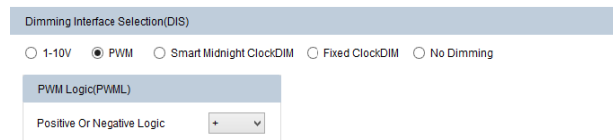

■ **Fade Time(FT)**



Set driver's "Fade up Time". This function is available in the Smart Midnight ClockDIM and Fixed ClockDIM mode; It means how much time the driver costs to achieve another dimming level from previous dimming level. The valid value is 0s, 1s, 2s, 5s, 10s, 20s, 40s.

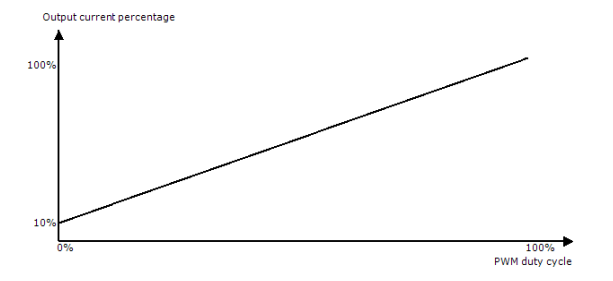

■ **1-10V**

Allow users to set the max and min output current and corresponding output voltage to clarify the 1-10V dimming curve. Input a 0~10V signal from 2nd pin of the dimming interface. Default: input ≤1V, output current 10%; input ≥ 8.5V, output current 100%.

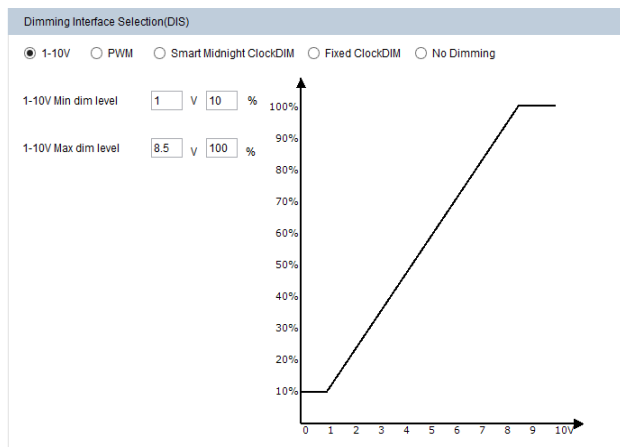

**■ Instruction**

**■ Integrated Dynadimmer**

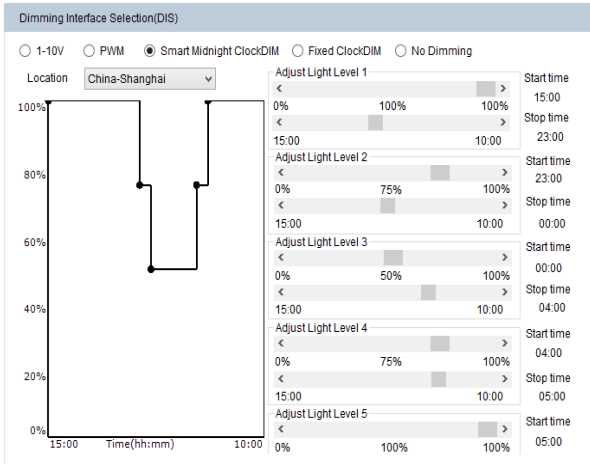

Integrated Dynadimmer allows dimming to predefined light levels based on the nightly operating time. With flexibility in setting time and light levels, the user can configure the driver for specific locations and application needs. Using Integrated Dynadimmer, it is possible to set up to 5 dim levels and time intervals. The driver does not have a real time clock. Instead it runs a virtual clock, determined by the length of nightly operating hours. After 3 ON-OFF cycles, the driver will calculate the virtual clock time. A valid ON-time is defined as a period during which the driver operates continuously for  $\geq 4$  hours to  $\leq 24$  hours. For example, if the requirement in summer is: 23:00-00:00: 75%, 00:00-04:00: 50%, 04:00-05:00: 75% (other time 100% or Off). The driver should be powered on for 7h, so it can calculate the virtual clock time as 22:00. Then we can set the dimming plan: 22:00~23:00: 100%, 23:00-00:00: 75%, 00:00-04:00: 50%, 04:00-05:00: 75%. From summer to winter, the valid ON-time changes day by day. The driver should be powered on for 17h in winter, and it also can calculate the virtual clock time as 17:00. Then the dimming plan is 17:00~23:00: 100%, 23:00-00:00: 75%, 00:00-04:00: 50%, 04:00-05:00: 75%, 05:00~10:00: 100%. From the above, if we set the dimming plan as shown in the picture, after repeating the driver ON-time for 3 consecutive days, the dimming plan takes effect from the 4th day onwards. Each day the driver powered on, it has a different start time according to the virtual clock time. So the driver can satisfy different requirements for different seasons.

**■ Constant Light Output(CLO)**

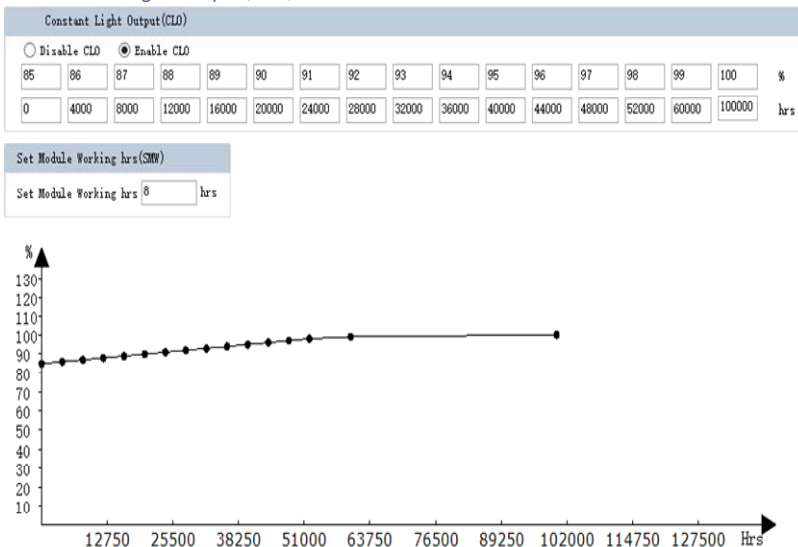

**■ Integrated Dynadimmer Time Based**

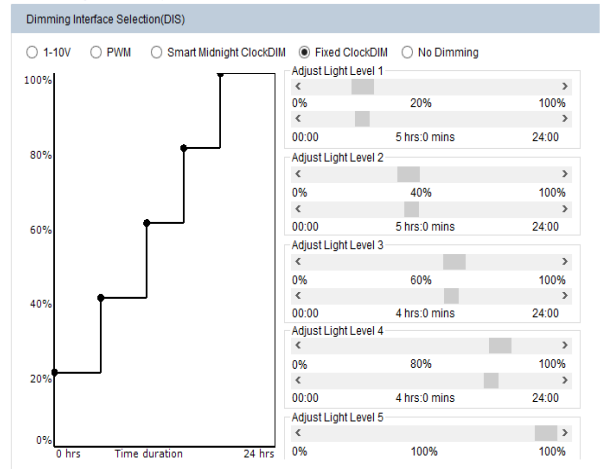

Allow users to separate 24hrs into 5 sections and corresponding output current.

**■ No Dimming**

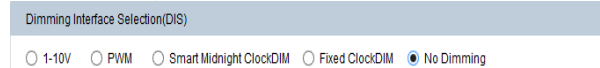

The driver will be in constant output mode.

**■ Set MODULE Working hrs(SMW)**

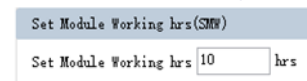

User can check how much time the driver works through this function.

Traditional light sources suffer from depreciation in light output over time. This applies to LED light sources as well. The CLO feature enables LED solutions to deliver constant lumen output through the life of the light engine. Based on the type of LEDs used, heat sinking and driver current, it is possible to estimate the depreciation of light output for specific LEDs and this information can be entered into the driver. The driver counts the number of light source working hours and will increase output current based on this input to enable CLO. When the CLO feature is enabled, the driver nominal output current will be defined by the CLO percentage as shown by the equation below:  

$$\text{Driver target nominal output current} = \text{CLO percentage} \times \text{AOC}$$
 For example, in the CLO profile shown in Figure, between 52,000-60,000 working hours, the CLO percentage is set at 98%. Assuming the nominal AOC is set to 500mA, the driver output current with CLO enabled will be  $0.98 \times 500 = 600$  mA.  
 The CLO percentage can be set to a value between 85%-100%, in increments of 1%. The LED module working hours can be set at any value between (0-100,000 hours).

■ Mechanical Specification

Dimensions (Unit: mm)

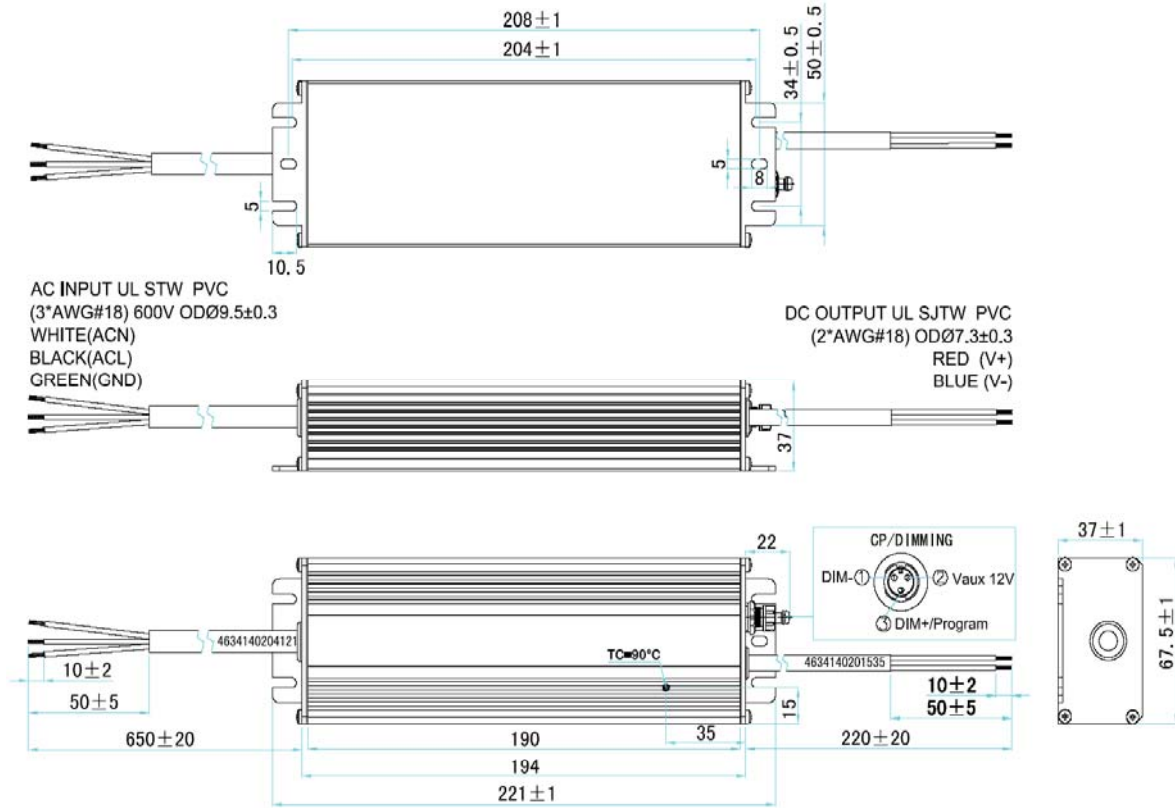

■ Nameplate

<ul style="list-style-type: none"> <li>● AC/L BLACK</li> <li>● AC/N WHITE</li> <li>● GREEN</li> </ul> <p><b>INPUT</b></p>	<p><b>MOONS'</b></p> <p><b>LED Driver</b> Energy Saving Solutions</p> <p><a href="http://www.moons.com.cn">Http://www.moons.com.cn</a> <a href="http://www.moonsindustries.com">Http://www.moonsindustries.com</a></p>	<p><b>MT100A105AQ_CP/C</b></p> <p>P/N: Input Voltage :277-480 Vac 50/60Hz Input Current :0.5A Output Voltage :57-150Vdc Adjustable Output Current :0.70-1.05A Settable</p>	 <p>Output Power:100W Suitable for use in Dry &amp; Damp Locations Type TL 90/67°C Type HL</p>	<p>RoHS</p> <p>MADE IN CHINA</p>	<p><b>DIM</b></p> <p>Dim+ Vaux 12V Dim- Program</p> <p><b>OUTPUT</b></p> <p>V-: BLUE ● V+: RED ●</p>
---	--	--	--	----------------------------------	--

RoHS Compliance:

Our products comply with the European Directive of LVD (2014/35/EU), WEEE (2012/19/EU) and ROHS (2011/65/EU and (EU) 2015/863), calling for the elimination of lead and other hazardous substances from electronic products.