

MOONS'	RELEASE DEPARTMENT: R&D	PAGE: 1 of 8
	TITLE: MU050S150BQI211 SPECIFICATIONS	
		REVISION: A0

oc No.: MSSD-6667 A0

LED DRIVER SPECIFICATIONS

Part Description: Input:90AC~305VAC,

Customer's Part Number:

MOONS' Part Number: **MU050S150BQI211**

Customer:

<p>Company:</p> <p>Department:</p> <p>Approved by:</p> <p>Date:</p>
--

EDITED:

DATE:

CHECKED:

DATE:

STANDARD:

DATE:

APPROVED:

DATE:

SHANGHAI MOONS' AUTOMATION CONTROL Co., LTD.



- **Features**
 - ◆ Input voltage: 100-277Vac , 140-388Vdc
 - ◆ Built-in active PFC function 0.95 Typ.
 - ◆ High efficiency: up to 87% Typ.
 - ◆ Constant current, 2 channels output
 - ◆ 2 channels 0-10V control
 - ◆ 4 in 1: Tunable white(1500-6500K).Dim to warm(1500-3200K),Solo dimming, Dual dimming
 - ◆ Output current can be set from 150~1500mA
 - ◆ AUX output 12V,150mA
 - ◆ Protection: OVP, SCP,OPP, OTP
 - ◆ According with UL Class2、EN SELV
 - ◆ 5-year warranty

■ Specification

Model (MU050S150BQI211)						
Input	Efficiency(230Vac)	87% (Typical) at 55V/0.911A load condition				
	Efficiency(120Vac)	87% (Typical) at 55V/0.91A load condition				
	Voltage Range	90-305Vac , 126-427Vdc				
	Rated Input Voltage	100-277Vac , 140-388Vdc				
	Frequency Range (Hz)	50/60				
	Power Factor	>0.9 at 100~277Vac 50/60Hz input, with 50%~100% load conditions				
	THD	< 20%, at 100 ~ 277Vac 50/60Hz input, with 50% ~ 100% load conditions				
	AC Current(Typ.)	0.55A MAX at 120VAC , 0.3A MAX at 230VAC				
	Inrush Current(Typ.)	<10A at 100~277Vac input 25℃ cold start at 100% conditions .for more details in the attached graph				
	Input Power (W)	60(max)				
	Standby power (W)	<0.5W at input 120Vac, 230Vac				
	Leakage Current(max.)	0.75mA at 277Vac 60Hz input				
	Output	Output Voltage Range (V) _{Note.1}	8-55			
Output Current Range(mA)		150-1500.Support hot plug, without overshoot current .				
Rated Power (W)		50(max)				
Output channels		2				
Ripple Current		Output current 200~1500mA ripple LF(<120HZ) ≤ 3% Ripple = peak / average: ripple HF ≤ 30%				
Current Tolerance		±5%				
Line Regulation		±1%				
Load Regulation		±3%				
Setup, Rise Time		<0.5S @120V/60HZ, 230V/50HZ				
AUX output		12V± 3% ,150mA max				
Dimming Control		Output current ≤1mA				
		Isolated 0-10V dimming / 0.1%lo~100%lo ref. Dimming module diagram and dimming curve				
Protection	Open circuit protection(V)	60				
	Short Circuit	Power supply stops output, recovers automatically when fault condition removed				
	Over Power	Solo&Dual dimming the current drops by 5% per 100ms; Tunable white&Dim to warm each time drops 10%				
	Over Temperature	tc 100℃ ±10%. Hiccup mode,When the temperature of tc rise to 100℃(Typ.)				
Environment	Operating Temp.	-25~+50℃; tc 85℃				
	Operating Humidity	20~95%RH, non-condensing				
	Storage Temp., Humidity	-40~+85℃, 10~95%RH				
	Vibration	10~500Hz, 5G 12min/cycle, period for 72min each along X、Y、Z axis				
	Ingress Protection Rating	IP20				
Safety & EMC	Safety Standard	UL8750, CSA C22.2 No.250.13-14, EN61347-1, EN61347-2:13				
		Isolation	Input	Output	Dimming interface	Enclosure
		Input	No applicable	3.75KV	3KV	1.875KV
		Output	3.75KV	No applicable	500V	1.5KV
		Dimming interface	3KV	500V	No applicable	500V
	Enclosure	1.875KV	1.5KV	500V	No applicable	
Isolation Resistance	I/P-O/P ,I/P-FG,O/P-FG:100M Ohms/500VDC/25℃/70%RH					
EMC Emission	FCC Part 15 ClassB, EN55015, EN61000-3-2 Class C, EN61000-3-3					
EMC Immunity	EN61000-4-2,3,4,5,6,8,11, EN61547 (Surge L,N-FG 2KV, L-N 1KV) Additional suger test L,N-FG 2.5KV;L-N 2.5KV					
Others	Life time	>50000 hours@Tc =70℃ at 100% load conditions				
	MTBF	300,000 hours, measured at full load, 25℃ ambient temperature MIL-HDBK-217F(25℃)				
	Dimension (LxWxH)	130x 76 x 30 mm (LxWxH)				
	Weight	375g				

Note.1: refer to V/I curve

■ Curve

Derating Curve

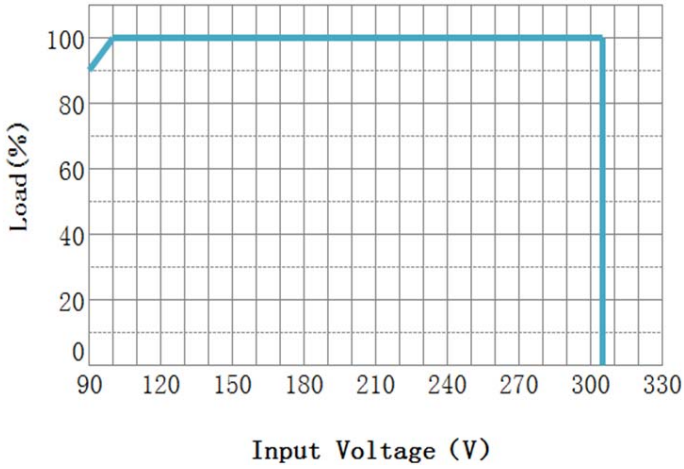

Derating Curve

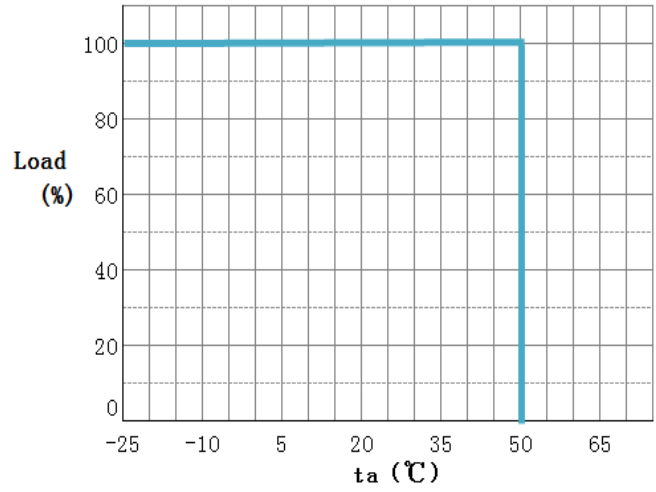

VI Curve

OPERATING RANGE/50W

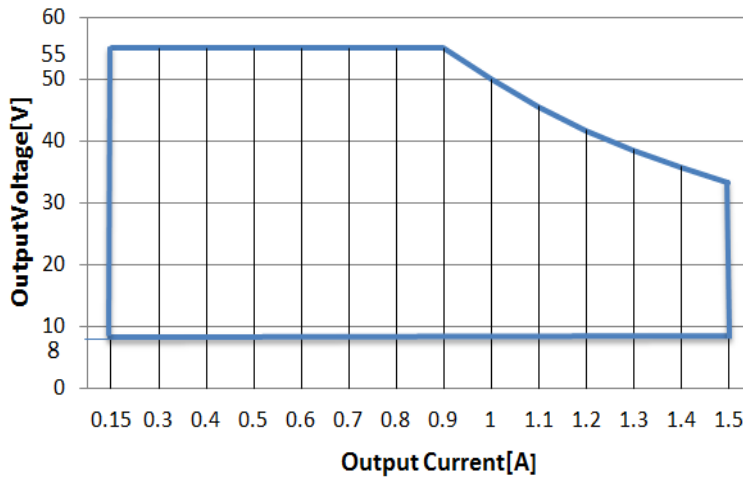

■ Curve

PF VS. Load Curve

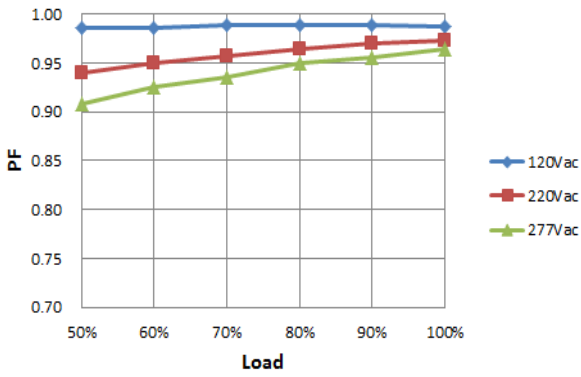

THD VS. Load Curve

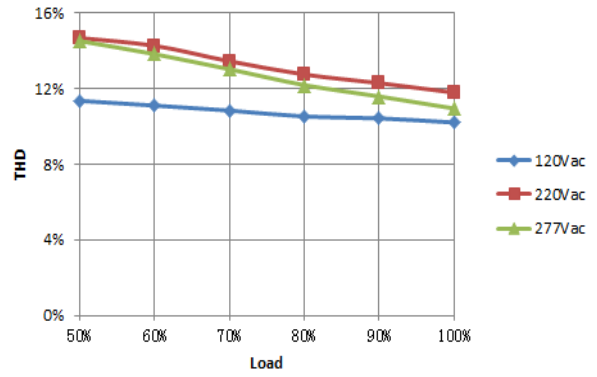

Efficiency VS. Load Curve

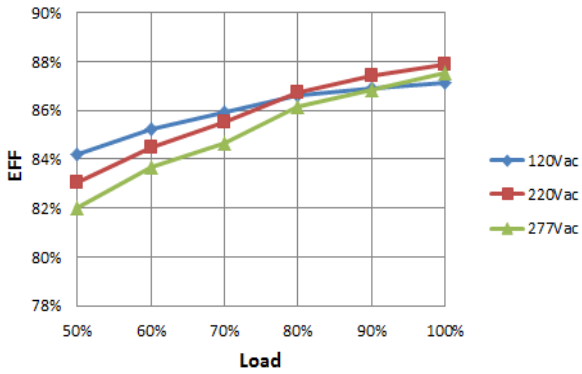

Curve

0-10V dim Curve

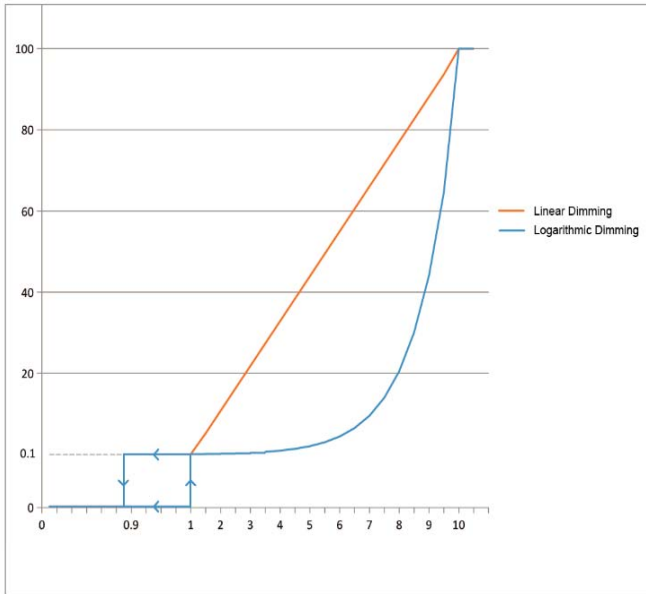

Inrush current waveform

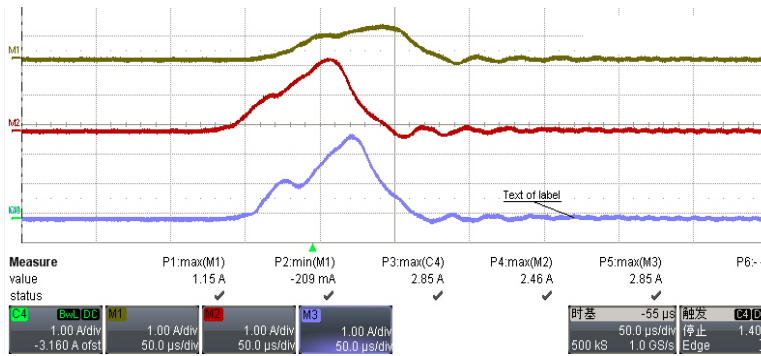

Inrush current information

Input voltage	Ipeak	Time@50% of Ipeak
120VAC	1.15	50us
220VAC	2.46	50us
277VAC	2.85	60us

Max number of drivers per MCB

Item	Max. number of drivers		
	120	220	277
Input voltage [VAC]	120	220	277
MCB B type 10A	16	30	34
MCB B type 13A	21	38	45
MCB B type 16A	26	47	56
MCB B type 20A	32	59	70
MCB B type 25A	40	74	87

■ Application of introduction

1. MCS interface(MCS+/MCS-)

- MCS+ interface voltage 15V
- Max current setting(each step is 1 mA), default driving current defined as 350mA.
- Log or linear dimming curve,default setting is log dimming.
- NTC thermal management protects LED lamp,when the temperature of LED lamp over temperature protection point, the current will be reduced by 50% every 5 minutes. Default setting is 85°C.

NTC compatibility list	NTC Manufacturer		NTC Model NO.	
		MURATA	NCP21WB473J03RA	
		VISHAY	NTCS0805e4473JXT	
		VISHAY	NTCLE100E3473	

- Control the status of Auxiliary power when dim level =0. Enable standby mode: when dim level =0, the Auxiliary power will be closed. Disable standby mode: when dim level =0, the auxiliary power still can work. Default setting is enable.
- update Online,use smart key to connect PC and the driver to update the firmware.

2. Dimming performance

- When changed to any dimming level, flicker wouldn't occur,dimming would be achieved smoothly.
- In the range of 200~1500mA,the current operating in continuous mode; In the range of 0~200mA,the current operating in PWM dimming mode, and the PWM frequency 3.6KHZ.

3. Guide for setting driver's parameters Touch setting

- Touch Setting
Program driver's parameters quickly and easily through Near Field Communication. Software download link:
http://leddriver.moons.com.cn/SouProduct/UCenter/M_Search/Software_view.aspx?MATNR=TouchSetting&rnd=1411
- Smartkey Network
Driver's parameters can be set through Smartkey Ver.A1 and Smartkey Network.What's more,driver's firmware can be updated through this tool. Software download link:
http://leddriver.moons.com.cn/SouProduct/UCenter/M_Search/Software_view.aspx?MATNR=SmartkeyNetwork&rnd=1411

4. Tunable white, Dim to warm , Solo dimming , Dual dimming function introduction

Tunable white	Cold color channel	CH1	Control port	DIM+CCT
	Warm color channel	CH2		
Dim to warm	Cold color channel	CH1	Control port	DIM
	Warm color channel	CH2		
Solo dimming	One 0-10V port control two output channels			
Dual dimming	Two 0-10V ports control two output channels			

6. Default factory settings

The screenshot shows a software interface for configuring the LED driver. At the top, there are icons for Load, Save, Read, Write, and Setting. Below these, there are sections for 'Current' and 'General Setting'. The 'Current' section has sliders and input boxes for Channel 1 and Channel 2, both set to 350 mA. The 'General Setting' section includes dropdown menus for Dimming Strategy (Solo 0-10V Dimming), Dimming Curve (Logarithmic), NTC (85), and AUX Enable (Enable). There are also input boxes for Minimum Dimming Level (0.1%), Input 0-10V Voltage Range (Upper: 10.0V, Lower: 1.0V), and Fade Time (300 ms).

■ **Mechanical Specification**

Dimensions(Unit:mm)

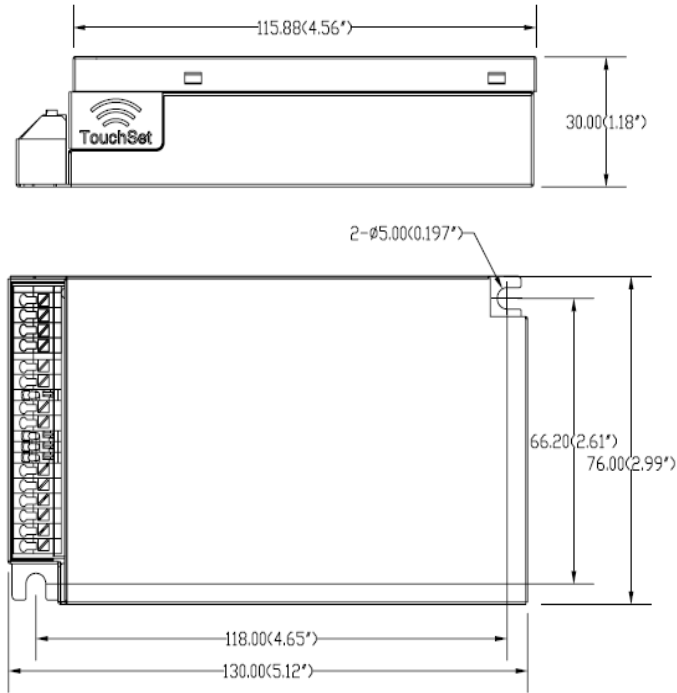

Port:

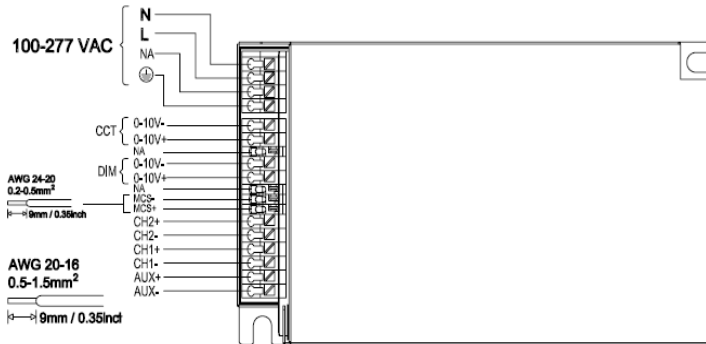

Normal connection using		Special connection using	
			<p>Get larger output current through parallel connection.</p> <p>Support common anode connection.</p>

RoHS Compliance:
Our products comply with the European Directive 2002/95/EC, calling for the elimination of lead and other hazardous substances from electronic products.