

- **Feature** · Input voltage: 90-305Vac
- Built-in active PFC function: 0.98 Typ.
- High efficiency: 93% Typ.
- Constant current/ 0-10V dimming/ clock dimming/ PWM dimming/Dim off
- Full power at 65%Iomax~100%Iomax (constant power)
- IP67 design for indoor or outdoor installations
- High surge immunity
- Compliance to worldwide safety regulations for lighting
- Suitable for dry/damp locations
- 5 Years Warranty



■ **Specification**

Model		'080	105	150	210	300	420	600	800	1000	1200	
(MU240HxxxAQ_CP)												
Efficiency (230Vac)(Typ.) _{Note.1}		93.0%	93.0%	93.0%	93.0%	93.0%	93.0%	93.0%	93.0%	93.0%	93.0%	
Voltage Range (V) _{Note.2}	90 ~ 305Vac, OR 127~ 430Vdc											
Voltage Rated (V) _{Note.2}	120 ~ 277Vac											
Frequency Range (Hz)	47~63											
Power Factor	PF>0.98/120VAC, PF>0.95/230VAC, PF>0.93/277VAC at full load											
THD	THD< 20% when output loading ≧ 80% at 120VAC/230VAC input and output loading ≧ 80% at 277VAC input											
AC Current (Max.)	2.5A MAX at 120Vac, 1.3A MAX at 230Vac											
Inrush Current (Max.)	COLD START 65A(twidth=680μs measured at 50% Ipeak) at 230VAC											
MAX. No. of PSUs on 16A CIRCUIT BREAKER	TBD											
Leakage Current (Max.)	0.75mA at 277Vac/60Hz											
Output	Rated Output Voltage (V)	453-300	343-228	240-160	171-114	120-80	86-57	60-40	40-30	30-24	24-20	
	Output Voltage Range (V)	453-181	343-137	240-96	171-68	120-48	86-34	60-24	40-16	30-12	24-12	
	Rated Current (mA)	530-800	700-1050	1000-1500	1400-2100	2000-3000	2800-4200	4000-6000	6000-8000	8000-10000	10000-12000	
	Output Current Range (mA)	53-800	70-1050	100-1500	140-2100	200-3000	280-4200	400-6000	600-8000	800-10000	1000-12000	
	Rated Power (W)	240W										
	Output Current Setting Range	6.5%-100% of I _{o_max}										
	Constant Power Setting Range	65%-100% of P _{o_max}										
	Ripple Current (Typ.)	10% of I _{o_max} . ((PK-AV) /AV) with LED default mode and full load)										
	Current Tolerance	±5%										
	Line Regulation	±3%										
	Load Regulation	±3%										
	Turn on delay Time	<1s, at 120Vac; <0.5s, at 230Vac										
	Dimming Control	12Vdc Output Voltage (Vdc)	10.8Vmin.~12Vtyp.~13.2Vmax.									
12Vdc Output Current(Vdc)		0mA~50mA max.										
0~10V/DIM+ Voltage		Absolute maximum voltage -10Vmin~20Vmax										
0~10V/DIM+ Short Current		280uA~450uA (DIM(+)=0)										
DIMMING FUNCTION		Default 0-10V dimming mode. Other dimming modes sets to PWM/Clock Dimming(CLK) by software configuration										
Protection	Over Voltage (V)(Typ.)	>500	>400	>300	>250	>180	>95	>80	>50	>40	>36	
	Short Circuit	Protection type: Voltage limiting.output will not exceed the upper limit voltage , recovers automatically after fault condition is removed.										
	Over temperature	Protection type: Decreases output current,returning to normal after over temperature is removed.										
Environment	Operating Temp.	-40~+50°C(Refer to 'Derating Curve')										
	Tc	90°C max										
	Operating Humidity	20~95%RH										
	Storage Temp., Humidity	-40~+85°C , 10-95%RH										
	Temp. Coefficient	0.03%/°C (0~50°C)										
Vibration	10-500Hz, 5G 12min/cycle, period for 72min each along X、 Y、 Z axes											
Safety & EMC	Safety Standard	UL8750, UL1012, CSA C22.2 NO.107.1, EN61347-1, EN61347-2-13										
	Withstand Voltage	I/P-O/P:3.75kVac, I/P-FG:1.875kVac, O/P-FG:1.5kVac										
	Isolation Resistance	I/P-O/P:100M Ohms (500VDC/25°C/70%RH)										
	EMC Emission	FCC Part 15 Class B/ EN55015, EN61000-3-2 Class C, EN61000-3-3										
	EMC Immunity	EN61000-4-2,3,4,5,6,8,11, EN61547 (Surge: L-N: ±4kV, L,N-FG: ±6kV)										
Others	MTBF	TBD										
	Dimension	251*67.5*40										
	Weight (Typ.)	1.2Kg										

Note.1: Measured at full load and steady-state temperature in 25°C ambient(Efficiency will be about 2% lower if measured immediately after startup); Note. 2: Derating may be needed under low input voltage, Please Refer to 'Derating Curve' ;

-Maximum Number of Drivers per MCB

ITEM	Max. Number of Drivers		
Input voltage (VAC)			
MCB B type 10A			
MCB B type 13A			
MCB B type 16A			
MCB B type 20A			
MCB B type 25A			

-Inrush current information

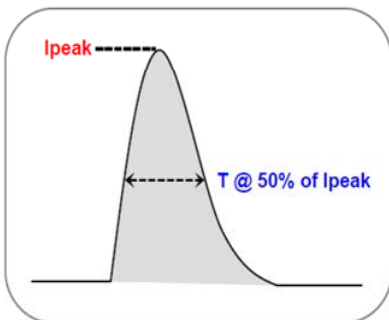

Input Voltage	Ipeak	'Time @ 50% of Ipeak
120VAC		
230VAC		
277VAC		

Derating Curve

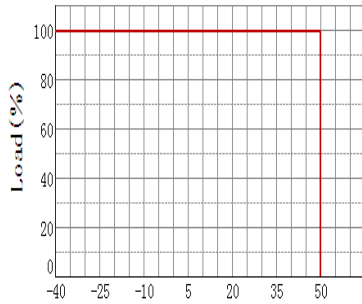

Ambient Temperature (°C)

V/I Curve

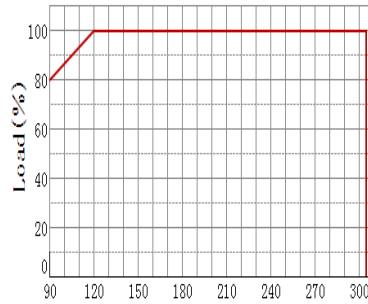

Input Voltage (V)

V/I Operating Area

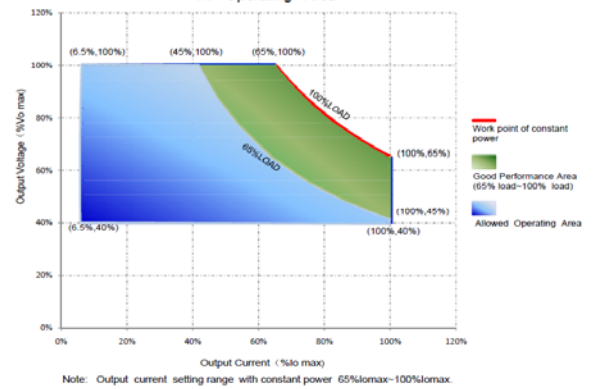

Power Factor VS. Load Curve(Model:6.8A)

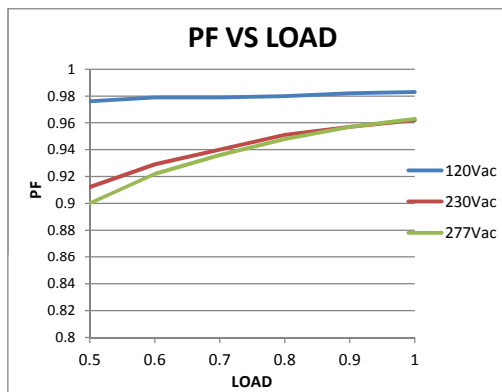

Efficiency VS. Load Curve(Model:6.8A)

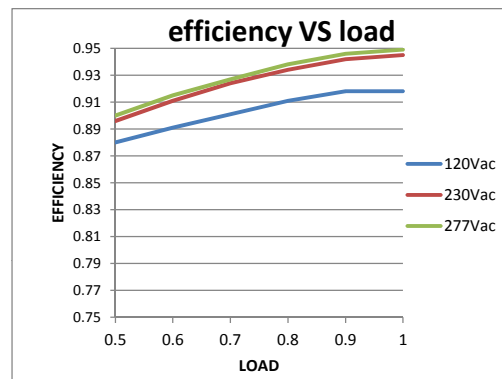

THD VS. Load Curve(Model:6.8A)

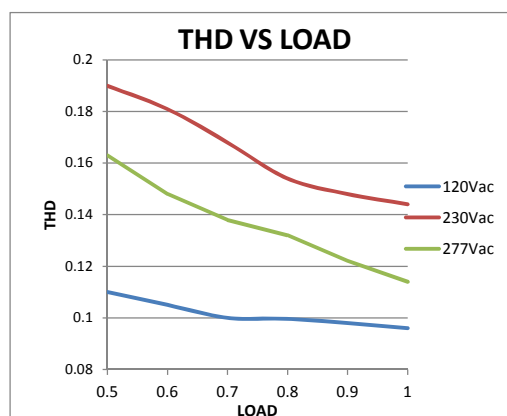

Life Time VS. Tcase (Ref.)(Model:6.8A)

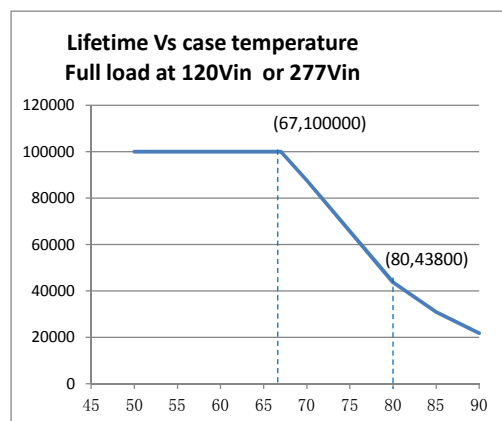

■ **Instruction**

1.Field Programmable Topology

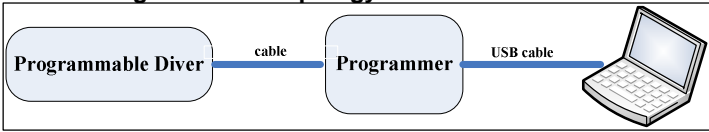

The programmable driver can be programmed by using special PC software and the programmer module.

2.Dimming Interface Description

Pin description

Pin	Name	Value	Description
1	Vaux 12V	10.8V-13.2V	Passive dimmers power supply
2	Dim+/Program	0-10V	Dimming/Programming input
3	Dim-	0V	DC Ground

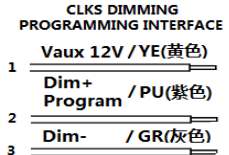

3.Dimming Software Function Instruction

■ Adjustable Output Current(AOC)

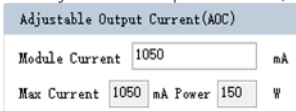

Users can set the rated current between 7%*Max Current and 100%*Max Current

■ Adjustable Startup Time(AST)

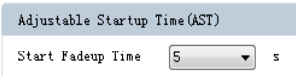

Set driver's "Start Fade up Time". It means how much time the driver costs to achieve the "Module Current" that the user set. The valid value is 0s, 1s, 2s, 5s, 10s, 20s, 40s.

■ Fade Time(FT)



Set driver's "Fade up Time". This function is available in the Smart Midnight ClockDIM and Fixed ClockDIM mode; It means how much time the driver costs to achieve another dimming level from previous dimming level. The valid value is 0s, 1s, 2s, 5s, 10s, 20s, 40s.

■ 1-10V

Allow users to set the max and min output current and corresponding output voltage to clarify the 1-10V dimming curve. Input a 0~10V signal from 2nd pin of the dimming interface. Default: input ≤1V, output current 10%; input ≥8.5V, output current 100%; input ≤0.5V, Dimming off, input ≥0.8V. Dimming on

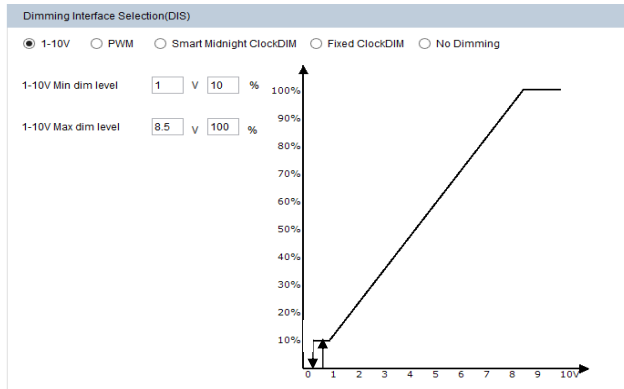

■ PWM

Input a PWM signal from the 2nd pin(Dim+/Program) of the dimming interface to change the output current. User can set "Positive Logic" or "Negative Logic" of the PWM signal. PWM duty cycle: 1%~99%(it has both positive and negative logics), frequency: 500Hz~5kHz, 3V~10V is high, 0.3V~0.8V is low.

Default: PWM ≤5%, Dimming off, PWM ≥8%, Dimming on

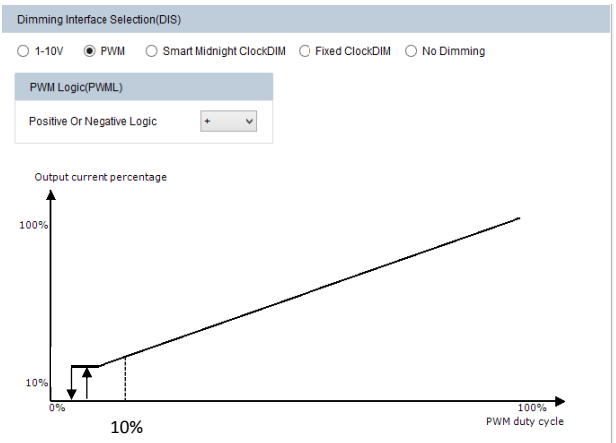

■ **Instruction**

■ **Integrated Dynadimmer**

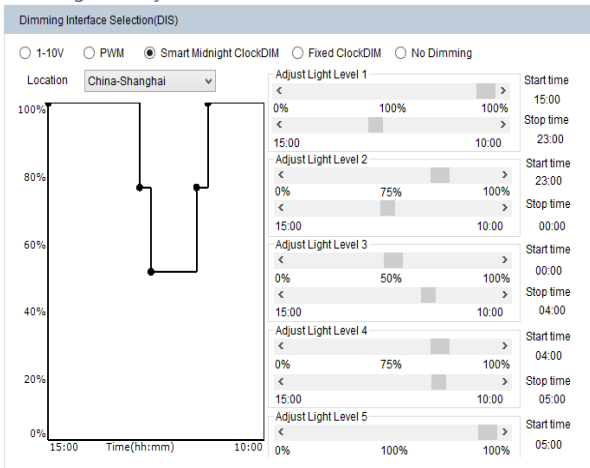

Integrated Dynadimmer allows dimming to predefined light levels based on the nightly operating time. With flexibility in setting time and light levels, the user can configure the driver for specific locations and application needs. Using Integrated Dynadimmer, it is possible to set up to 5 dim levels and time intervals. The driver does not have a real time clock. Instead it runs a virtual clock, determined by the length of nightly operating hours. After 3 ON-OFF cycles, the driver will calculate the virtual clock time. A valid ON-time is defined as a period during which the driver operates continuously for ≥ 4 hours to ≤ 24 hours. For example, if the requirement in summer is: 23:00-00:00: 75%, 00:00-04:00: 50%, 04:00-05:00: 75% (other time 100% or Off). The driver should be powered on for 7h, so it can calculate the virtual clock time as 22:00. Then we can set the dimming plan: 22:00~23:00: 100%, 23:00-00:00: 75%, 00:00-04:00: 50%, 04:00-05:00: 75%. From summer to winter, the valid ON-time changes day by day. The driver should be powered on for 17h in winter, and it also can calculate the virtual clock time as 17:00. Then the dimming plan is 17:00~23:00: 100%, 23:00-00:00: 75%, 00:00-04:00: 50%, 04:00-05:00: 75%, 05:00~10:00: 100%. From the above, if we set the dimming plan as shown in the picture, after repeating the driver ON-time for 3 consecutive days, the dimming plan takes effect from the 4th day onwards. Each day the driver powered on, it has a different start time according to the virtual clock time. So the driver can satisfy different requirements for different seasons.

■ **Constant Light Output(CLO)**

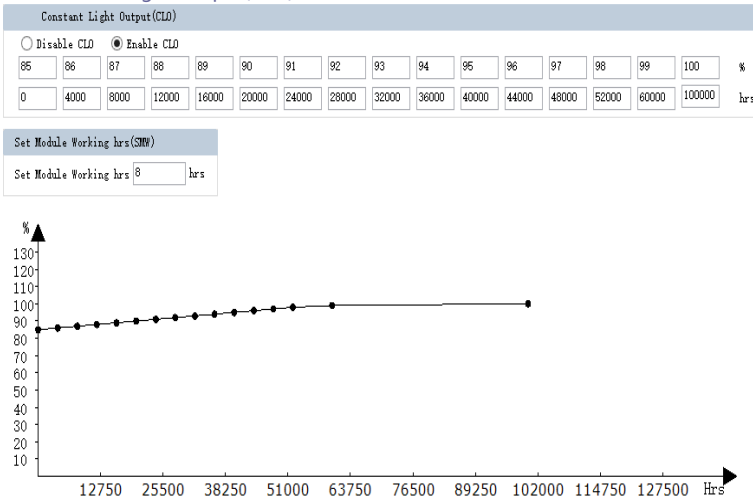

■ **Integrated Dynadimmer Time Based**

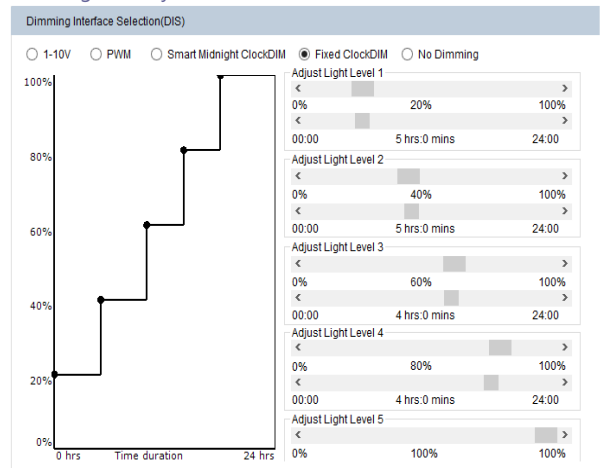

Allow users to separate 24hrs into 5 sections and corresponding output current.

■ **No Dimming**

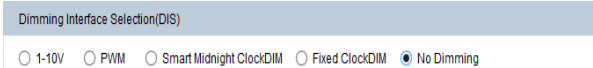

The driver will be in constant output mode.

■ **Set MODULE Working hrs(SMW)**

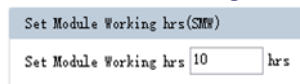

User can check how much time the driver works through this function.

Traditional light sources suffer from depreciation in light output over time. This applies to LED light sources as well. The CLO feature enables LED solutions to deliver constant lumen output through the life of the light engine. Based on the type of LEDs used, heat sinking and driver current, it is possible to estimate the depreciation of light output for specific LEDs and this information can be entered into the driver. The driver counts the number of light source working hours and will increase output current based on this input to enable CLO. When the CLO feature is enabled, the driver nominal output current will be defined by the CLO percentage as shown by the equation below:
Driver target nominal output current = CLO percentage * AOC. For example, in the CLO profile shown in Figure, between 52,000-60,000 working hours, the CLO percentage is set at 98%. Assuming the nominal AOC is set to 500mA, the driver output current with CLO enabled will be $0.98 \times 500 = 600$ mA. The CLO percentage can be set to a value between 85%-100%, in increments of 1%. The LED module working hours can be set at any value between (0-100,000 hours).

■ Mechanical Specification

Dimensions (Unit: mm)

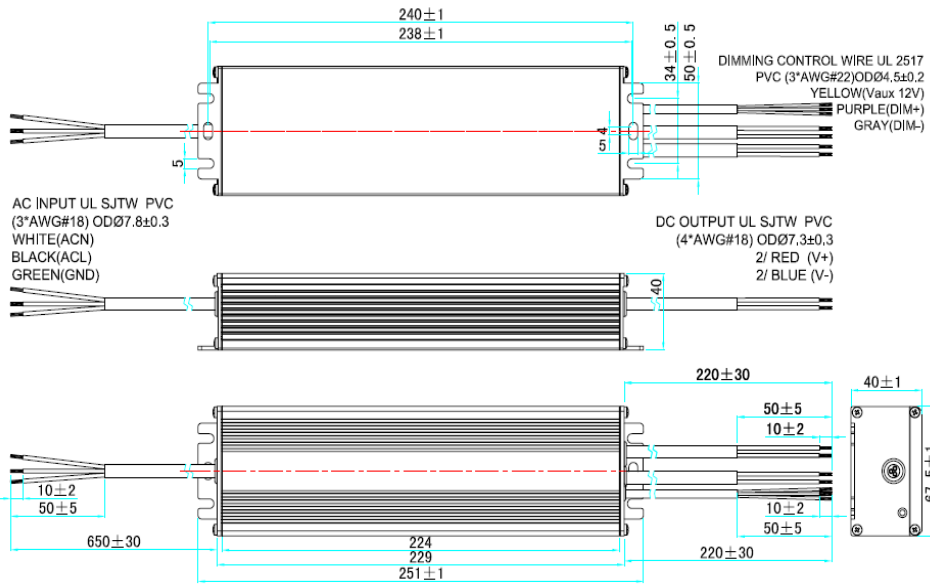

For output current >6A

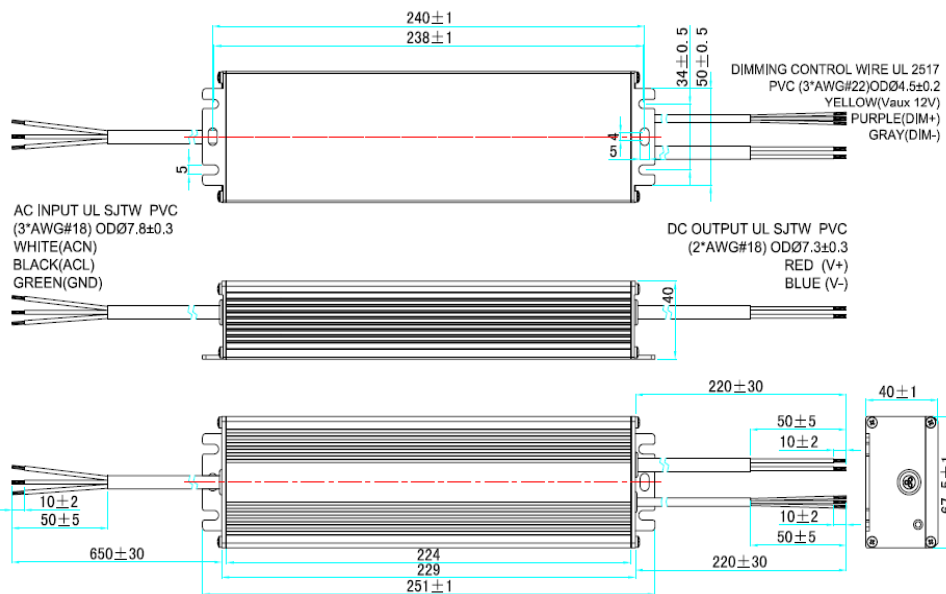

For output current ≤6A

■ Label

TBD

RoHS Compliance:

Our products comply with the European Directive 2002/95/EC, calling for the elimination of lead and other hazardous substances from electronic products.