

SRAC8

AC Input Step Motor Drive

Quick Set-Up Guide

Requirements

To use the SRAC8 Step Drive, the following items are needed:

- Universal AC input of 80 to 265 VAC
- Pulse & Direction signal
- A compatible step motor

Connect to Power

Use the supplied connector to connect to the AC supply according to the diagram below. Use 16 AWG wire for Line (L) and Neutral (N). Use 14 AWG for Earth Ground (G).

The SRAC8 has an internal 10A fast acting fuse.

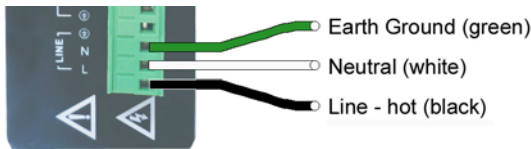

Care should be taken when working with high voltages.

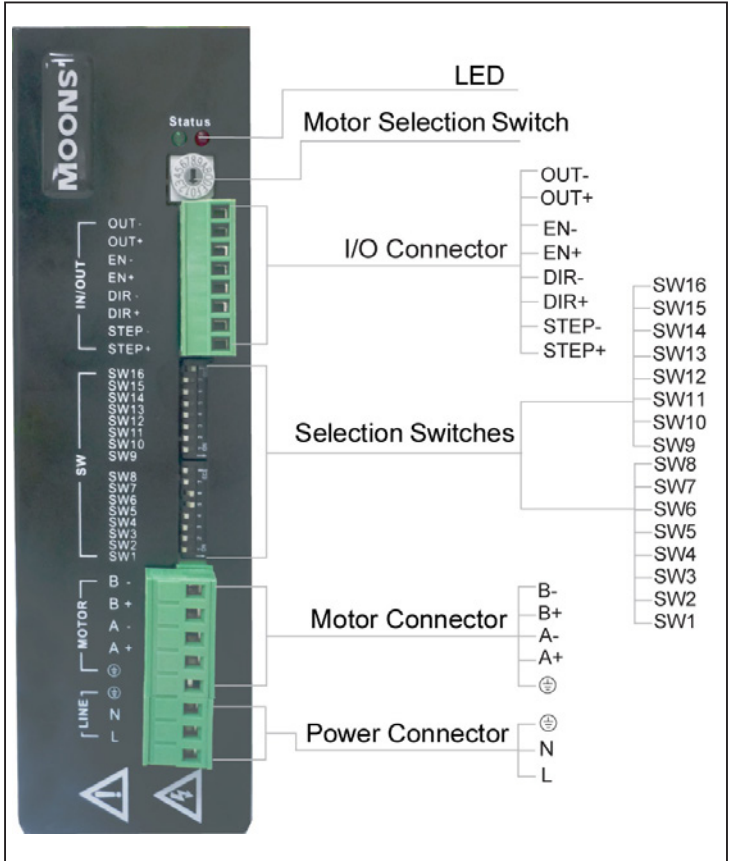

Connecting to a Motor

Connect the drive to the motor. Four lead motors can be connected in only one way. If using a non MOONS' motor, consult the motor specs for wiring information.

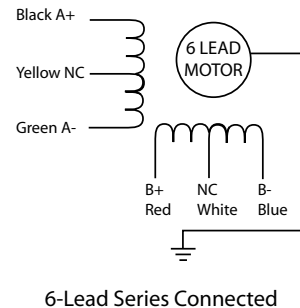
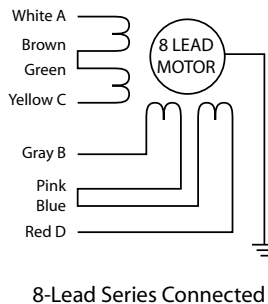
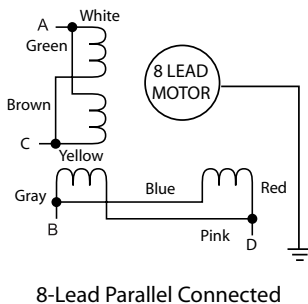
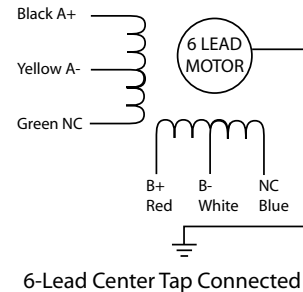
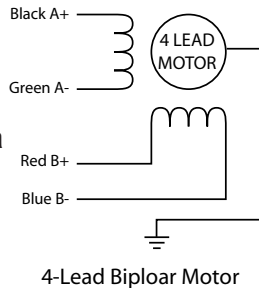
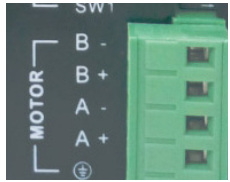

Selecting the Motor

Each position of the 16-bit rotary selects a different motor, automatically setting the configuration parameters in the drive. The SRAC8 drive comes programmed with up to 16 typical motors as factory defaults. Drives can be customized with specially selected motors when required. Available options are listed on the drive label. Each motor in the loaded database has unique settings to optimize the anti-resonance.

If the motor selection is changed, the drive power supply will need to be cycled.



Selection Switches

Many operational parameters of the SRAC8 can be set or changed by position switches - either by a single switch or a combination of ON/OFF settings of 2 or more switches.

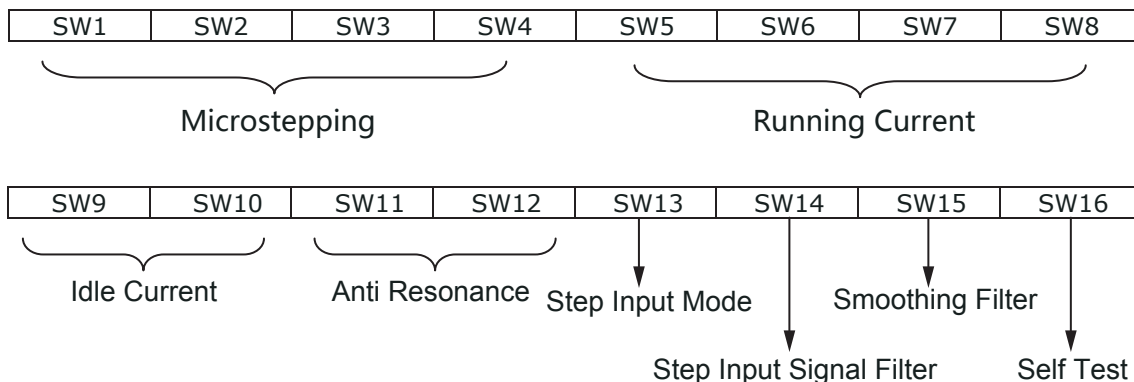

Microstepping - 4 switches for a total of 16 settings:

| Microstep(step/rev) | SW1 | SW2 | SW3 | SW4 |
|---------------------|-----|-----|-----|-----|
| 200 | ON | ON | ON | ON |
| 400 | OFF | ON | ON | ON |
| 800 | ON | OFF | ON | ON |
| 1600 | OFF | OFF | ON | ON |
| 3200 | ON | ON | OFF | ON |
| 6400 | OFF | ON | OFF | ON |
| 12800 | ON | OFF | OFF | ON |
| 25600 | OFF | OFF | OFF | ON |
| 1000 | ON | ON | ON | OFF |
| 2000 | OFF | ON | ON | OFF |
| 4000 | ON | OFF | ON | OFF |
| 5000 | OFF | OFF | ON | OFF |
| 8000 | ON | ON | OFF | OFF |
| 10000 | OFF | ON | OFF | OFF |
| 20000 | ON | OFF | OFF | OFF |
| 25000 | OFF | OFF | OFF | OFF |

Idle Current - 2 switches for a total of 4 settings:

| Idle | SW9 | SW10 |
|------|-----|------|
| 25% | ON | ON |
| 50% | OFF | ON |
| 70% | ON | OFF |
| 90% | OFF | OFF |

Step Input Mode (**SW13**) - OFF for Step and Direction input, ON for CW/CCW input

Step Smoothing Filter (**SW15**) - ON to enable, OFF to disable

Running current - 4 switches for a total of 16 settings:

| Current(Peak) | SW5 | SW6 | SW7 | SW8 |
|---------------|-----|-----|-----|-----|
| 0.4A | ON | ON | ON | ON |
| 0.6A | OFF | ON | ON | ON |
| 0.9A | ON | OFF | ON | ON |
| 1.2A | OFF | OFF | ON | ON |
| 1.5A | ON | ON | OFF | ON |
| 2.0A | OFF | ON | OFF | ON |
| 2.5A | ON | OFF | OFF | ON |
| 3.0A | OFF | OFF | OFF | ON |
| 3.5A | ON | ON | ON | OFF |
| 4.0A | OFF | ON | ON | OFF |
| 4.5A | ON | OFF | ON | OFF |
| 5.2A | OFF | OFF | ON | OFF |
| 5.9A | ON | ON | OFF | OFF |
| 6.6A | OFF | ON | OFF | OFF |
| 7.3A | ON | OFF | OFF | OFF |
| 8.0A | OFF | OFF | OFF | OFF |

Anti-Resonance - 2 switches for a total of 4 settings:

| Option | SW11 | SW12 | Inertia |
|--------|------|------|-----------|
| 0 | ON | ON | Low |
| 1 | OFF | ON | ↓ High |
| 2 | ON | OFF | |
| 3 | OFF | OFF | |

Step Input Signal Filter (**SW14**) - ON for 150 kHz, OFF for 2 MHz

Self test (**SW16**) - ON for 2 rev CW/CCW .5 rps self test, OFF for none

Safety Instructions



- Only qualified personnel should assemble, install, operate, or maintain this equipment.
- Read all available documentation before assembly and operation.
- It is vital to ensure that all system components are connected to earth ground.
- This product contains electrostatically sensitive components that can be damaged by incorrect handling.